

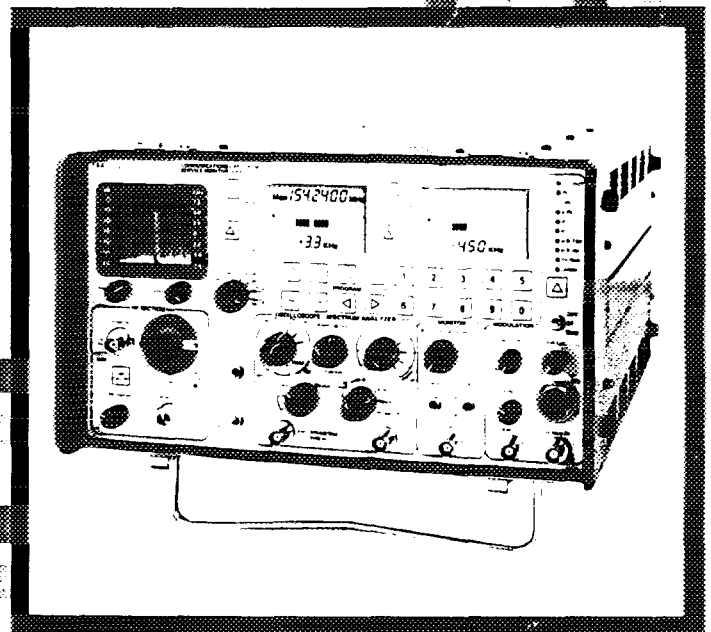

MOTOROLA INC.

test equipment

**Communications
Service Monitor
OPERATORS' MANUAL**



R-2200/R-2400





MOTOROLA INC.

Communications
Sector

R-2200/R-2400 Communications Service Monitor

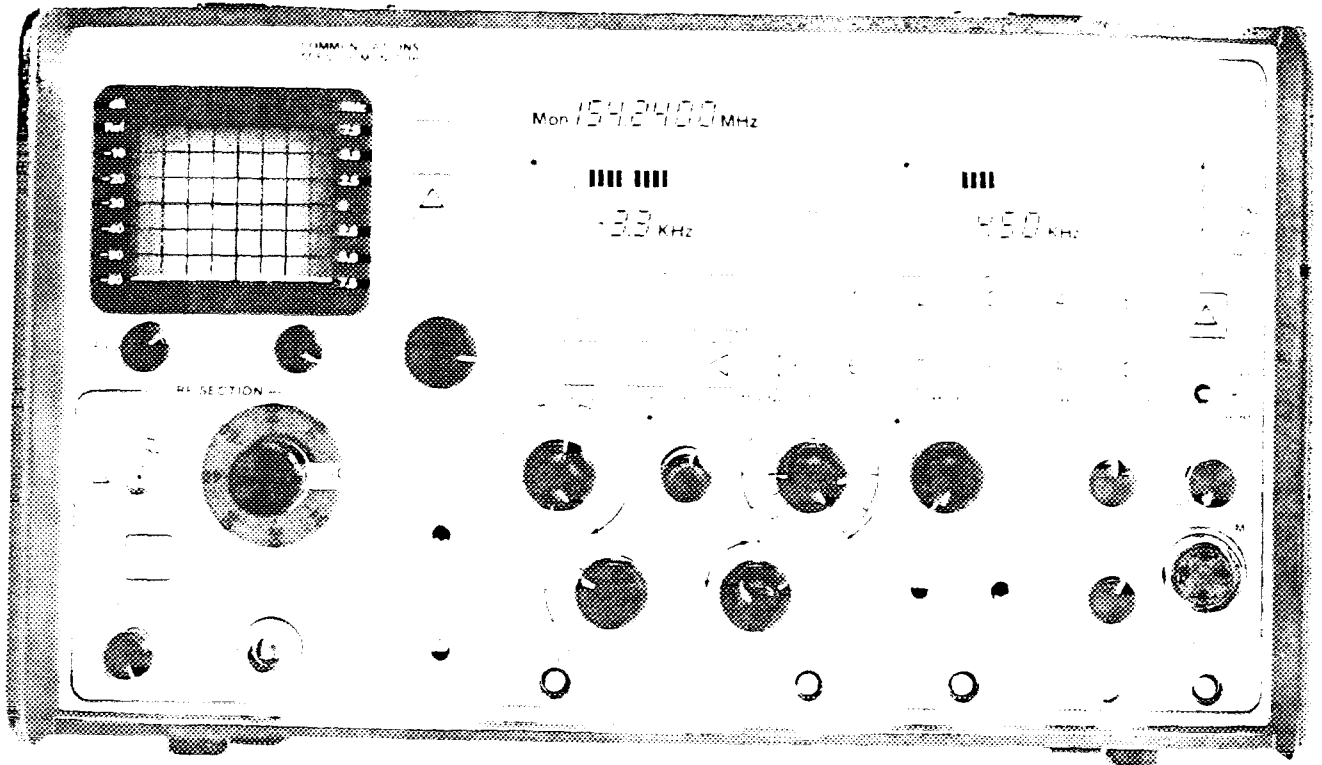

4.2.1	Parameter Memory	4-1
4.2.2	Default Parameters	4-1
4.3.0	Generate Operation	4-1
4.3.1	Output Level	4-1
4.3.2	Mode Select	4-2
4.3.3	Simultaneous Generate And Measurement Operation	4-2
4.3.4	Testing Pager Decode And Alert Function	4-2
4.4.0	Monitor Operation	4-3
4.4.1	Sensitive Monitor	4-3
4.4.1.1	Sens Mon With Spectrum Analyzer (R-2400 only)	4-3
4.4.2	Power Monitor	4-3
4.4.2.1	Pwr Mon With Spectrum Analyzer (R-2400 only)	4-4
4.4.3	Transmitter Distortion Measurements	4-4
4.4.4	Measurement Of Transmitted PL	4-4
4.4.5	Simultaneous Oscilloscope/DVM Operation	4-4
Section 5 – Applications		
5.1.0	Service Shop Setups	5-1
5.1.1	Spectrum Analyzer	5-1
5.1.2	Operating Notes For The R-2400 Service Monitor With Spectrum Analyzer	5-1
5.2.0	Receiver Sensitivity Test 12 dB SINAD Audio Distortion	5-2
5.3.0	Receiver Sensitivity Test 20 dB Quieting	5-2
5.4.0	Squelch Sensitivity Test	5-2
5.5.0	Audio Power Output Test	5-3
5.6.0	Audio Frequency Response	5-3
5.7.0	Modulation Acceptance Bandwidth	5-4
5.8.0	RF Preselector Shape And Bandwidth	5-4
5.9.0	Receiver Frequency Adjustment	5-4
5.10.0	Basic FM Transmitter Test: Power, Frequency And Deviation	5-5
5.11.0	Transmitter Audio Distortion	5-7
5.12.0	Transmitter Audio Frequency Response	5-7
5.13.0	AM Modulation Test	5-7
5.14.0	Cavity And Duplexer Tuning Bandpass Adjustment	5-8
5.15.0	Cavity And Duplexer Tuning Bandpass With Reject Notch - Receive Leg	5-8
5.16.0	Cavity And Duplexer Tuning Bandpass With Reject Notch - Transmit Leg	5-9
5.17.0	Desensitization Test In Service Duplexer	5-9
Section 6 – Maintenance		
6.1.0	Battery Kit Installation	6-1
6.1.1	Battery Charging	6-1
6.1.2	Operation From An External DC Power Source	6-1
6.1.3	Shipping Instructions	6-2
6.1.4	Two-Way Service Option Installation	6-2

FOREWORD

1. SCOPE OF MANUAL

This manual is intended for use by experienced technicians with similar types of equipment. It contains all the service information required for the equipment described and is current as of the printing date. Changes which occur after the printing date are incorporated by Instruction Manual Revisions (SMR). These SMR's are added to the manuals as the engineering changes are incorporated into the equipment.

2. MODEL AND KIT IDENTIFICATION

Motorola equipments are specifically identified by an overall model number on the nameplate. In most cases, assemblies and kits which make up the equipment also have kit model numbers stamped on them. When a production or engineering change is incorporated, the applicable schematic diagrams are updated.

As diagrams are updated, information about the change is incorporated into a revision column. This revision column appears in the manual next to the parts list or, in some cases, on the diagram. It lists the reference number, part number, and description of the parts removed or replaced.

3. SERVICE

The Motorola Test Equipment Repair Center is charged with the service responsibility for all test equipment supplied by the Motorola Communications Sector. The center maintains a stock of original equipment replacement parts and a complete library of service information for all Motorola test equipment.

Most in-warranty repairs are performed at the center. Exceptions include repairs on some equipment not manufactured by Motorola which are performed by

the original supplier under the direction of the Motorola Test Equipment Repair Center. Out-of-warranty service is performed on a time and materials basis at competitive rates. Customer satisfaction is continually surveyed by reply cards returned with repaired instruments.

The Motorola Test Equipment Repair Center also provides a convenient telephone troubleshooting service. Frequently, a user technician can troubleshoot a piece of equipment and isolate the defective components under the direction of the Motorola Test Equipment Repair Center via telephone. Required replacement parts are then immediately shipped to the user thereby reducing shipping time and servicing costs. For telephone troubleshooting contact the Motorola Test Equipment Repair Center toll free at (800) 323-6967.

All other inquiries and requests for test equipment calibration and repairs should be directed to the Motorola Area Parts Office. They will contact the Motorola Test Equipment Repair Center, process the necessary paperwork and, if necessary, have the Center contact you to expedite the repair.

4. REPLACEMENT PARTS ORDERING

Motorola maintains a number of parts offices strategically located throughout the United States. These facilities are staffed to process parts orders, identify part numbers, and otherwise assist in the maintenance and repair of Motorola Communications products.

Orders for all replacement parts should be sent to the nearest area parts and service center listed below. When ordering replacement parts the complete identification number located on the equipment should be included.



MOTOROLA INC.

Communications
Sector

SAFE HANDLING OF CMOS INTEGRATED CIRCUIT DEVICES

Many of the integrated circuit devices used in communications equipment are of the CMOS (Complementary Metal Oxide Semiconductor) type. Because of their high open circuit impedance, CMOS ICs are vulnerable to damage from static charges. Care must be taken in handling, shipping, and servicing them and the assemblies in which they are used.

Even though protection devices are provided in CMOS IC inputs, the protection is effective only against overvoltage in the hundreds of volts range such as are encountered in an operating system. In a system, circuit elements distribute static charges and load the CMOS circuits, decreasing the chance of damage. *However, CMOS circuits can be damaged by improper handling of the modules even in a system.*

To avoid damage to circuits, observe the following handling, shipping, and servicing precautions.

1. Prior to and while servicing a circuit module, particularly after moving within the service area, momentarily touch *both* hands to a bare metal earth grounded surface. This will discharge any static charge which may have accumulated on the person doing the servicing.

NOTE

Wearing Conductive Wrist Strap (Motorola No. RSX-4015A) will minimize static buildup during servicing.

WARNING

When wearing Conductive Wrist Strap, be careful near sources of high voltage. The good ground provided by the wrist strap will also increase the danger of lethal shock from accidentally touching high voltage sources.

2. Whenever possible, avoid touching any electrically conductive parts of the circuit module with your hands.

3. Normally, circuit modules can be inserted or removed with power applied to the unit. However, check the INSTALLATION and MAINTENANCE sections of the manual as well as the module schematic diagram to insure there are no objections to this practice.

4. When servicing a circuit module, avoid carpeted areas, dry environments, and certain types of clothing (silk, nylon, etc.) because they contribute to static buildup.

5. All electrically powered test equipment should be grounded. *Apply the ground lead* from the test equipment to the circuit module *before* connecting the *test probe*. Similarly, *disconnect the test probe prior* to removing the *ground lead*.

6. If a circuit module is removed from the system, it is desirable to lay it on a conductive surface (such as a sheet of aluminum foil) which is connected to ground through 100k of resistance.

WARNING

If the aluminum foil is connected directly to ground, be cautious of possible electrical shock from contacting the foil at the same time as other electrical circuits.

7. When soldering, be sure the soldering iron is grounded.

8. Prior to connecting jumpers, replacing circuit components, or touching CMOS pins (if this becomes necessary in the replacement of an integrated circuit device), be sure to discharge any static buildup as described in procedure 1. Since voltage differences can exist across the human body, it is recommended that only one hand be used if it is necessary to touch pins on the CMOS device and associated board wiring.

9. When replacing a CMOS integrated circuit device, leave the device in its metal rail container or conductive foam until it is to be inserted into the printed circuit module.

10. All low impedance test equipment (such as pulse generators, etc.) should be connected to CMOS

device inputs after power is applied to the CMOS circuitry. Similarly, such low impedance equipment should be disconnected before power is turned off.

11. Replacement modules shipped separately from the factory will be packaged in a conductive material. Any modules being transported from one area to another should be wrapped in a similar material (aluminum foil may be used). NEVER USE NON-CONDUCTIVE MATERIAL for packaging these modules.

SECTION I

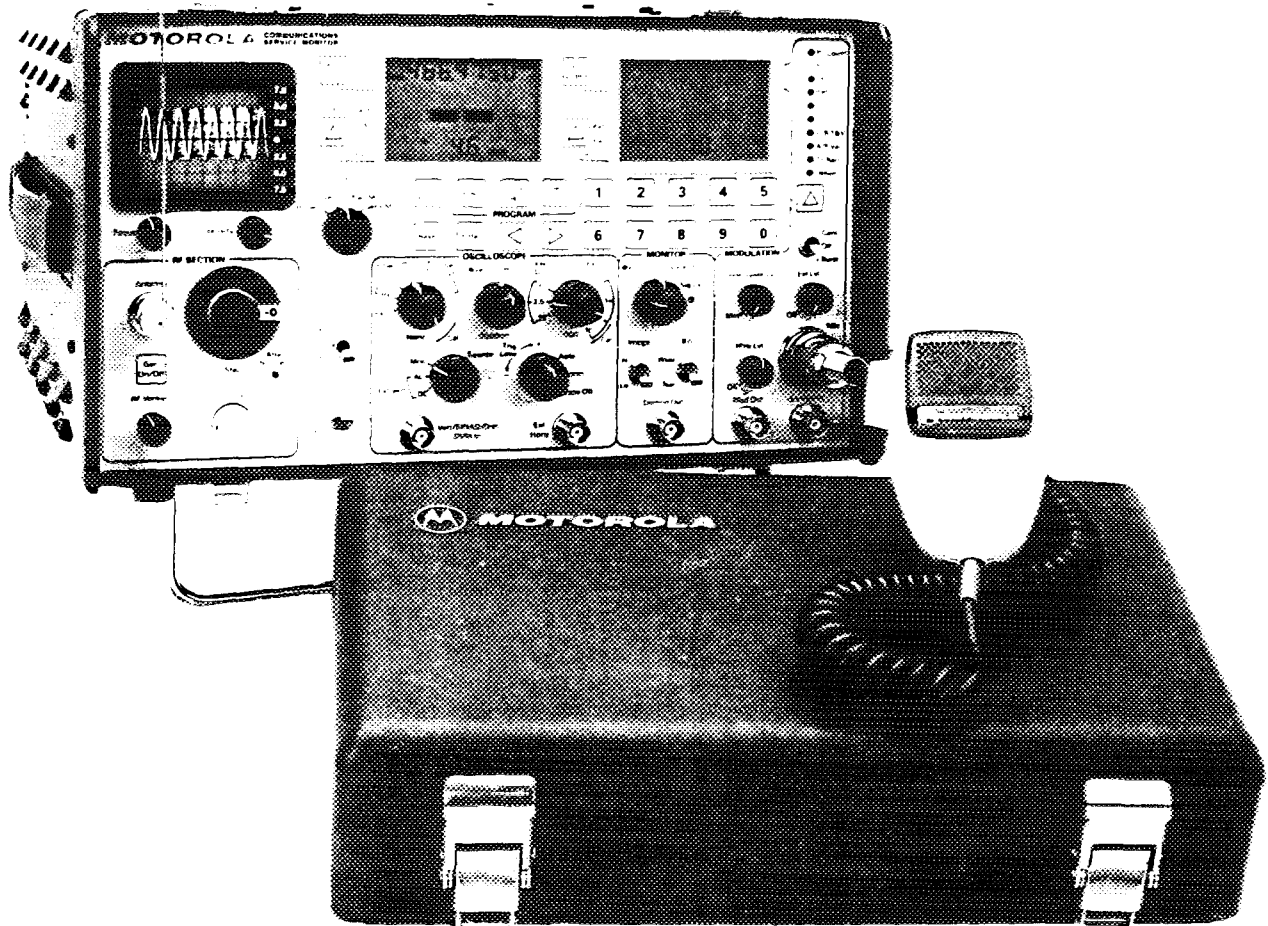

Figure 1-1. Communications Service Monitor

SECTION 1 SPECIFICATIONS

1.1.0 GENERAL This section lists the physical, electrical and input/output characteristics of the Communications Service Monitor shown in figure 1-1.

1.2.0 SPECIFICATIONS

<p>Modes: AM/FM Generate, Monitor, Power Monitor, Voltmeter, DC, RMS, AC, RF Wattmeter and Load, Oscilloscope</p>	<p>General</p>
<p>Signal Generator Mode</p>	<p>OSCILLOSCOPE Size: 200 mm diagonal Freq. Response: DC to 15 MHz (3 dB point)</p>
<p>FREQUENCY Range: 200 kHz to 999.9999 MHz Resolution: 100 Hz Accuracy: Same as time base</p>	<p>EXTERNAL VERTICAL INPUT Ranges: 10 mV, 100 mV, 1 V, 10 V per division Sweep Rates: 1us, 10us, 100us, 1ms, 10ms, 100ms per division Sync: Automatic or adjustable level triggering</p>
<p>OUTPUT (16 dB variable in 10 dB steps over 8 ranges) Range: .05uV to 800uV (low level output) 40uV to 1V (high level output) Accuracy: ±2 dB over the .1 uV to 1V range of output level ±2 dB leveling over the 200 kHz to 750 MHz freq. range ±3 dB leveling over the 750 MHz to 999.9999 MHz frequency range ±1 dB over the operating temperature range ref. 25° C</p>	<p>DIGITAL VOLTMETER Readout: 3 digit Autoranging 1, 10, 100, 300 volts full scale DC Accuracy: ±1% F.S. + LSD AC Accuracy: ±5% F.S. AC Bandwidth: 50 Hz to 10 kHz</p>
<p>PURITY Spurious: -40 dB Harmonics: -15 dB (step attenuator = 0 dB, 0 dBm out)</p>	<p>CODE SYNTHESIZER & AUDIO GEN. Frequency Range: 50 Hz to 9.999 kHz Resolution: 0.1 Hz 50 to 1000 Hz, 1 Hz 1000 Hz to 9999 Hz Accuracy: ±.01% Special Function: PL, DPL, DPL invert, 2 tone sequential, 2 tone variable, tone remote Output Level: 0 to 3 RMS @ 600 Ohms</p>
<p>FREQUENCY MODULATION Deviation: 0 to 50 kHz peak FM Noise: 100 Hz External/Internal Frequency Range: 5 Hz to 10 kHz Modes: External, internal or microphone (any or all)</p>	<p>SINAD Meter Input level range: 5 V to 10 VRMS Accuracy: ±1 dB @ 12 dB SINAD Distortion: (1 kHz using code synthesizer for tone) Range: 0 to 35 dB Input Level Range: 5 V to 10 VRMS Accuracy: 5% of F.S. from 1% to 50% PL Counter Range: 80 to 270 Hz Resolution: 0.1 Hz</p>
<p>AMPLITUDE MODULATION</p>	<p>TIME BASE Standard TCXO: Aging ± 1 x 10⁻⁶ Yr Temp. ± 1 x 10⁻⁶ from 0 to -55 C Optional OCXO: Aging ± 1 x 10⁻⁶ Yr Temp. ± 5 x 10⁻⁸ max.</p>
<p>Range: 0 to 50% from 1 to 500 MHz External/Internal Frequency Range: 100 Hz-10 kHz (± 1 dB) External Input: Approx. 150mV for 50% BNC connector Modes: Internal, external, microphone or all simultaneously</p>	<p>Power and Environmental</p>
<p>Monitor Mode</p>	<p>AC: 90 to 130, 180 to 250 V ac, 50/60 Hz DC: ±11.0 to +17 V dc Optional Battery: 12 V battery provides approx. 1 hr. continuous operation Battery Weight: 8 lbs. (3.63 kg) Temp. Range: 0 to +55 C Dimensions: 11.1" high x 12.1" wide x 14" deep (19.0 cm x 31.8 cm x 35.6 cm) Weight: 30 lb. excluding battery pack (13.6 kg)</p>
<p>Frequency Range: 3 MHz to 999.9999 MHz useable to 100 KHz with reduced sensitivity Resolution: 100 Hz Accuracy: Same as time base Frequency Error Indicator: Digital Display of frequency error and bar graph</p>	<p>R-2400 Spectrum Analyzer</p>
<p>Sensitivity: 1.5 uV for 10 dB EIA SINAD (narrowband ± 7 KHz mod. acceptance) 5 uV for 10 dB EIA SINAD (wideband ± 100 kHz mod. acceptance) 5 uV for 10 dB EIA SINAD AM Spurious Response: -40 dB Typical 0 dB image ± 21.4 MHz -10 dB at L.O. harmonic ± 10.7 MHz</p>	<p>Dispersions: 0.1, 0.01 MHz/div Dynamic Range: 85 dB min. Measurement Range: -100 dbm to +27 dbm at Antenna connector using internal RF step attenuator Accuracy: ±.5 db absolute (at frequencies below 800 MHz); ±.2 db linearity Useable to +51 dbm at RF In/Out conn. (level uncalibrated) Display Range: Level: 6 divisions at 10 db per division Frequency: 8 divisions with switch selectable dispersions of 1, .1, and .01 MHz per division Noise desensitization: -55 dbc at .01 MHz/div dispersion and 25 KHz freq. offset; -70 dbc at 1 MHz/div dispersion and 1 MHz offset Audio Monitoring: Simultaneous Monitor function with spectrum analyzer display of received signal.</p>
<p>FM DEVIATION MEASUREMENT Range: 1, 10, 100 kHz full scale Accuracy: ±5% of reading ± 100 Hz, 500 Hz to 50 kHz deviation, ±10% of reading 50 kHz to 75 kHz</p>	
<p>AM MODULATION MEASUREMENT</p>	
<p>Range: 0 to 100%</p>	
<p>Accuracy: ±5% of full scale</p>	
<p>RF WATTMETER AND LOAD Frequency Range: 1 MHz to 1000 MHz Power Range: 5 watt to 125 watt Accuracy: ±10% Protection: over temp. and over power alarms</p>	

SECTION 2

DESCRIPTION

2.1.0 DESCRIPTION

The R-2200 and R-2400 are test instruments designed and manufactured by Motorola to perform the most commonly used tests on radio communications equipment. Rugged and portable, the Communications Service Monitors are designed for technician productivity.

2.2.0 MICROPROCESSOR TECHNOLOGY

The R-2200 and R-2400 Communications Service Monitors use advanced engineering design based upon a Motorola M-6800 series microprocessor. The units feature liquid crystal displays (LCD) and a sealed membrane keyboard for easy and accurate entry of data. The LCD's show exactly what displays and functions are active at any time. The displays change as you switch monitor functions, and prevent you from selecting an invalid readout.

2.3.0 MULTIPLE FUNCTIONS

The microprocessor design permits a wide variety of service applications. The R-2200 is capable of performing tests which require:

- Modulation Oscilloscope
- "Off-the-Air" PL Counter
- Multimode Code Synthesizer
- AC/DC Digital Analog Voltmeter
- General Purpose Oscilloscope
- SINAD Meter
- Distortion Meter
- RF Wattmeter

as well as the traditional service monitor functions of SIGNAL GENERATION, FREQUENCY ERROR and MODULATION measurements. In addition, the R-2400 provides a spectrum analyzer display while simultaneously monitoring the received signal.

2.4.0 PORTABILITY

Weighing under 30 lbs. (13.6 kg), the unit's form factor is engineered for ease of carrying. The optional internal battery allows 1 hour continuous operation. Time is saved since the technician has to transport less equipment and does not have to take time to unpack, hook-up, disconnect and repack additional equipment.

2.5.0 DURABILITY

The R-2200 and R-2400 are field environment tough and meet the shock and vibration portions of EIA specification RS152B. The units have been subjected to accelerated life testing, during the design stage, to ensure the best possible design and reliability. The Mylar covered keyboard is sealed against moisture, dirt, dust and oil.

2.6.0 HUMAN ENGINEERING

The R-2200 and R-2400 are human engineered. The membrane keyboard with audible feedback ensures accurate data entry. Front panel controls are grouped by function for simple operation. The microprocessor controlled LCDs provide autoranging analog and digital displays.

2.7.0 AM/FM SIGNAL GENERATOR

The built-in general purpose signal generator provides continuous coverage of the HF, VHF, and UHF land mobile spectrum for receiver testing. Many forms of external and internal modulation can be simultaneously impressed on the carrier signal for actual composite signals. The frequency range of the RF signal generator is from 200 KHz to 1 GHz in 100 Hz steps. The output of up to 1 VRMS provides sufficient amplitude to get through misaligned tuners and receivers and is especially effective when changing a receiver's frequency. The high level, calibrated output is available over the entire frequency range of the Communications Service Monitor.

2.8.0 SINAD METERING

A comprehensive check of receiver performance can be made with a SINAD measurement. The analog meter bars and digital display of SINAD appear automatically whenever that measurement mode is selected. Hook-up is simple with only two connections required and measurements can then be accomplished without the need for a separate signal generator, SINAD meter or distortion analyzer.

2.9.0 DISTORTION METER

The distortion meter provides receiver or transmitter audio stage quality measurement without a separate signal generator or distortion meter. It also provides higher resolution than an oscilloscope to ensure the radio under test meets all distortion specifications.

2.10.0 TERMINATED RF POWER MEASUREMENT

RF power is measured when the Communications Service Monitor is in the power monitor mode. The built-in RF load dissipates up to 125 watts. If a higher powered transmitter should be keyed into the unit or if a lower power transmitter is keyed into the unit for a prolonged time threatening overheating of the power measuring circuitry, the audible alarm sounds and the LCD's display changes to read "OVER POWER" or "OVER TEMP", thus warning the technician to de-key. The instrument is further enhanced by the simultaneous indication of RF power output, carrier frequency error and modulation, all at the same time.

2.11.0 OFF-THE-AIR MONITOR

The 1.5 microvolt sensitivity of the Communications Service Monitor receiver allows off-the-air monitoring and measurement of transmitter frequency error and deviation to 1000 MHz. A variable squelch allows weak signals to be monitored, but can be set tighter to ensure the proper signal-to-noise ratio for measurement accuracy. The off-the-air monitor function enables frequent parameter checks without leaving the shop, thus spotting system degradation early and keeping service costs down. Bandwidth can be set "WIDE" for off-channel signal location or wide band FM; or "NARROW" for maximum sensitivity and selectivity.

2.12.0 OFF-THE-AIR PRIVATE LINE FREQUENCY COUNTER

Identifies the PL frequency of any radio under test to allow complete testing of PL subaudible tone signalling.

2.13.0 MULTIPURPOSE OSCILLOSCOPE

This general purpose scope is ideal for waveform analysis in two-way communication servicing. Use it for viewing modulation signals (either internally or externally generated), detection of asymmetric modulation or audio distortion, and general purpose signal tracing and troubleshooting.

2.14.0 MULTIMODE CODE SYNTHESIZER

The Communications Service Monitor generates PRIVATE LINE tones (PL), DIGITAL PRIVATE LINE codes (DPL), two-tone sequential paging codes and tone-remote signalling tones. All codes are available at the "MOD OUT" jack, as well as being used internally to modulate the RF signal generator. This eliminates the necessity of using separate generators and oscillators for general servicing, setting transmitter deviation, or for checking tone remote base control lines.

2.15.0 SIMULTANEOUS MODULATION

Modulation is simultaneously available from an internal 1 KHz tone generator, a multimode code synthesizer, and from external inputs. The external modulation can be voice from a standard Motorola mobile radio microphone (which plugs into the front panel of the instrument), as well as a signal applied to the external BNC input. Separate controls are provided for independently setting the levels of the 1 KHz tone, the code synthesizer, and the external modulation sources. The 1 KHz test tone is a convenient source of modulation for making SINAD measurements. A "MOD OUT" connector provides external access to all of the modulation signals.

2.16.0 DIGITAL/ANALOG VOLTMETER

The built-in voltmeter provides circuit and power supply service capability. AC voltage reading are RMS values.

2.17.0 SPECTRUM ANALYZER

The R-2400 includes a spectrum analyzer which provides frequency spectrum display while allowing the user to monitor the audio of the programmed frequency signal. Three dispersions of 1, .1, and .01 MHz/div are available. In "Anl'r Sens Mon", the "Antenna" port is used. The range of power levels displayed when the step attenuator is in the 0 dB position is -40 dBm (top graticule) to -100 dBm (noise floor). Vertical divisions are 10 dB each. When 70 dB attenuation is added using the step attenuator, the range of power levels displayed becomes +27 dBm to -30 dBm. Care must be taken to not exceed the maximum input level of .5 watt (+27 dBm) at the Antenna input. In "Anl'r Pwr Mon", the RF signal that is applied to the "RF In/Out" port is sampled and displayed. The required amount of attenuation to maintain an on-screen display can be adjusted with the step attenuator.

2.18.0 THE FIRST IN A SERIES/TWO-WAY SERVICE OPTION

The TWO-WAY SERVICE OPTION is the first in a series of new option cards. This PC board, plug in compatible with any R-2200 (or R-2400) via an open option module slot and comes equipped with the following functions:

TWO-WAY SERVICE OPTION

- DPL DECODE
- DTMF ENCODE
- DTMF DECODE

Some of the major features of the DPL Decoder includes OFF-THE-AIR decoding of DPL or IDPL codes. The Two-Way Service Option will decode only valid DPL codes and will not display invalid codes. With the DPL encoder, standard in every R-2200 (or R-2400), the service technician has a "failsafe operation" making it easier and less time consuming when performing a complete DPL system check.

The option card also provides multiple methods in which to encode DTMF tones. The most basic form of generating DTMF, a real time encoder, is one selection possible. There are also encoding formats available for operator selection which include: 1) 16 digit storage (BATCH ENCODE), 2) user programmable timing, and 3) simultaneous PL and DTMF encode.

A last function of the Two-Way Option is DTMF Decode. In this mode the service monitor will decode DTMF tones OFF-THE-AIR or via the modulation input BNC connector. This option will decode and store up to 16 DTMF digits.

With DPL, DTMF and the standard PL Encode and Decode built-in, the R-2210 and R-2410 Communications Service Monitors qualify as a complete signalling simulator, capable of performing a complete signalling system check on the land mobile industries most common signalling formats.

SECTION 3 OPERATION

3.1.0 INTRODUCTION

To become proficient, an operator must know the equipment and its capabilities. Before operating the service monitor, carefully study the purpose and function of each switch and indicator described here and become familiar with the operating procedures given.

3.1.1 SWITCH AND INDICATORS

See figures 1,2,3,4,5,6,7, and 8 for the location of assemblies, controls and indicators on the front of the service monitor.

3.2.0 GENERAL

The service monitor is the radio communication technician's universal tool. It is required to service and maintain most AM, FM and CW two-way radio equipment and needs to provide accurate measurements, have durability and offer fast, efficient use. This service monitor was designed to meet all these criteria. A front view of the service monitor, (figure 3-1), reveals two liquid crystal displays which will provide the digital and analog readouts for any mode of operation selected. To the left, is a modulation oscilloscope to display modulation waveforms received or generated by the service monitor. It can also be used as a general purpose oscilloscope for routine trouble shooting procedures. In the R-2400, it functions as a spectrum analyzer. A sealed membrane keypad is used for all data entry. Each time a pushbutton is actuated an audible feedback tone will tell the operator the entry has been accepted. Operation is discussed in paragraph 3.4.0. Specific controls are grouped by function and outlined with red graphics to

reduce operator confusion. Each section will be covered in detail later. The RF SECTION with RF carrier In/Out controls is at the bottom left. The OSCILLOSCOPE controls are to the right and include the multi-purpose input used for SINAD, distortion, digital volt meter and oscilloscope vertical inputs. In the R-2400, the frequency dispersion is controlled by this section. Next is the MONITOR section with speaker and squelch controls for off the air monitoring and on the right, a MULTIMODE CODE SYNTHESIZER to allow the technician to modulate an RF carrier signal with PL,DPL, timed signalling formats, and external sources such as a microphone or audio generator.

3.2.1 POWER

The power on/off switch is a three position toggle switch. In the full down position, "OFF", the unit is turned off. The center position, "STBY", removes power from all circuits except for the battery charger and frequency standard. This allows battery charging when not in use and maintains stability of the crystal oscillator. This is especially important for high stability units. In the up position, "ON", all circuits are powered.

3.2.2 MODE SWITCH

The mode select switch is a three position toggle switch which selects the type of signal to be monitored or generated. The "FM" position allows the unit to monitor or generate frequency modulated signals. The "CW" position allows the unit to generate unmodulated RF signals and the "AM" position generates or monitors amplitude modulated signals.

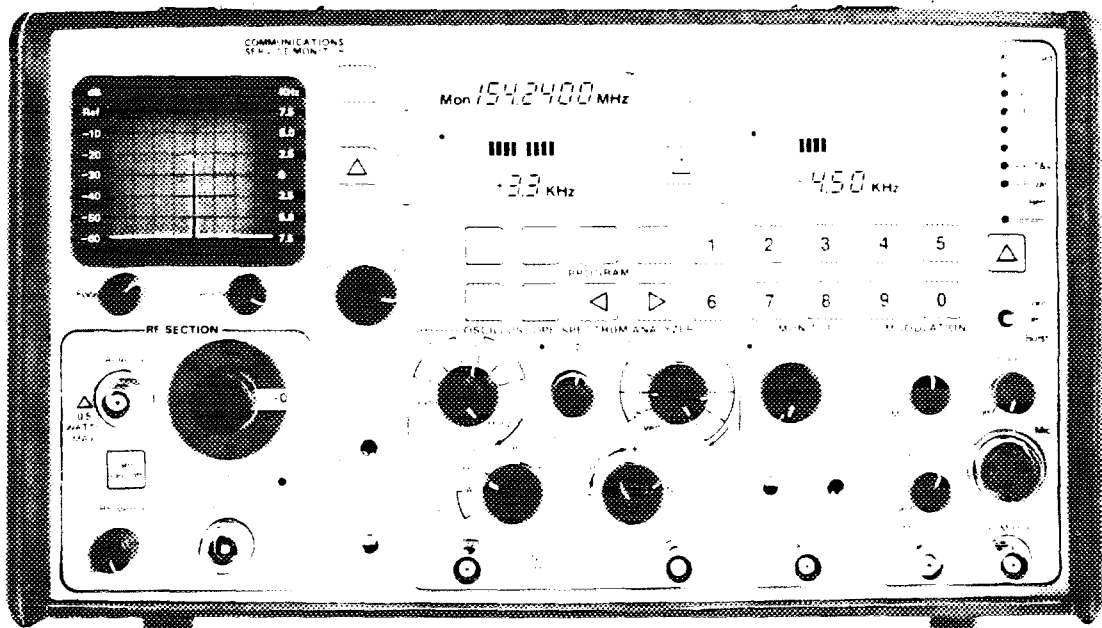



FIGURE 3-1—CLOSEUP FRONT VIEW

3.2.3 FUNCTION SWITCH

3.2.3.1 GENERATE FUNCTIONS The function switch is a four position rotary switch which permits the service monitor to be used as an RF signal generator specified from 200 kHz to 999.9999 MHz or an RF signal monitor specified from 1 MHz to 999.999 MHz. In the "HIGEN" (high generate) function the unit generates and outputs an RF signal and is capable of 200 uV to 1 VRMS output on any frequency within the specified range. The 1 volt output level is sufficient for transmission through an antenna connected to the antenna connector. In the "GEN" (generate) function the unit generates an RF signal for direct connection to the antenna input of the equipment under service with output levels from .1 uV to 200 uV.

3.2.3.2 MONITOR FUNCTIONS The "SENS MON" (sensitive monitor) function allows the unit to monitor low level signals. The 1.5 microvolt sensitivity allows off the air monitoring of a remote transmitter's frequency error and deviation/% modulation (of modulated carriers). Hookup is made to the "ANTENNA" connector. Selecting the "PWR MON" (power monitor) function permits the service monitor to operate as an RF wattmeter, allowing direct output power measurement of transmitters within the range of .5 to 125 watts. Frequency error and deviation/% modulation measurements are also available in the "PWR MON" function. Hookup is made to the "RF IN/OUT" connector. The R-2400 has two additional function switch positions, "Anlzl Sens Mon" and "Anlzl Pwr Mon" which are used to enter the analyzer mode of operation. In "Anlzl Sens Mon", the signal applied to the "Antenna" input is displayed. In "Anlzl Pwr Mon", the signal applied to the "RF In/Out" input is displayed. All other functions are the same as for "Pwr Mon" and "Sens Mon".

3.3.0 LIQUID CRYSTAL DISPLAY MODE SELECT

Notice the cursor controls  on the left and right LCD's. These controls select the various measurement modes. Each time the cursor control is depressed the annunciator DOT located on the left side of each LCD screen will move and an audible feedback tone will verify actuation. The equipment is programmed to suppress measurement modes not relevant to the selected service monitor function. For example, when in the "GENERATE" function, frequency error and power (on the right LCD) cannot be accessed. This reduces operation time and increases productivity. See table 1 for software defined selections.

3.3.1 LIQUID CRYSTAL DISPLAYS

3.3.1.1 ANALOG METER BARS/DIGITAL DISPLAYS



As shown in fig. 3-2 the LCD's provide autoranging analog and digital displays. Digital displays provide accuracy and autoranging meter bars assist during peaking and dipping maintenance adjustments. To provide efficient operation the digital readouts of selected modes

TABLE 3-1

FUNCTION SWITCH POSITION	ACCEPTABLE MEASUREMENT MODE	SUPPRESSED MEASUREMENT MODE
GENERATE HI GENERATE	DEVIATION ALARM DEV/% AM DVM DISTORTION SINAD BATTERY VOLTAGE RF LEVEL	FREQ ERROR POWER
POWER MONITOR OR ANALYZER POWER MONITOR	DEVIATION ALARM DEV/% AM DVM DISTORTION POWER FREQ ERROR BATTERY VOLTAGE SINAD	RF LEVEL
SENSITIVE MONITOR OR ANALYZER SENSITIVE MONITOR	DEVIATION ALARM DEV/% AM DVM DISTORTION FREQ ERROR BATTERY VOLTAGE SINAD	POWER RF LEVEL

are presented at the same time as analog displays. With display modes selected for RF signal measurements such as FM deviation or frequency error, the meter bars operate about a center point and show symmetrical or non-symmetrical deviation or drifting about the center frequency. In "% AM", the meter bar graph operates about a center point and shows positive and negative percentage of amplitude modulation. Other display mode analog meter bars (distortion, power) have zero reference on the left with autoranging meter bar displays increasing to the right. SINAD has a "reverse" meter bar graph. As SINAD values get larger in a range of 0-20 dB the meter bar graph gets smaller. The voltmeter display, "DVM", has left to right meter bars for all AC signals and positive DC signals. For negative DC signals, the meter bars move right to left with zero reference at the right.

3.3.1.2 SPECIAL DISPLAY SELECT SWITCHES

Three special membrane switches are provided to control the digital volt meter, RF level and deviation/percent AM modes. The  is used to select the FM deviation or AM modulation positive or negative peaks. In the "DEV/% AM" measurement mode, deviation is automatically selected if in FM and %AM is automatically selected if in AM. The  is used to select the display for either AC or DC voltages and the  provides the "RF LEVEL" digital readout in volts or dBm. These keys will respond only when the associated function is active.

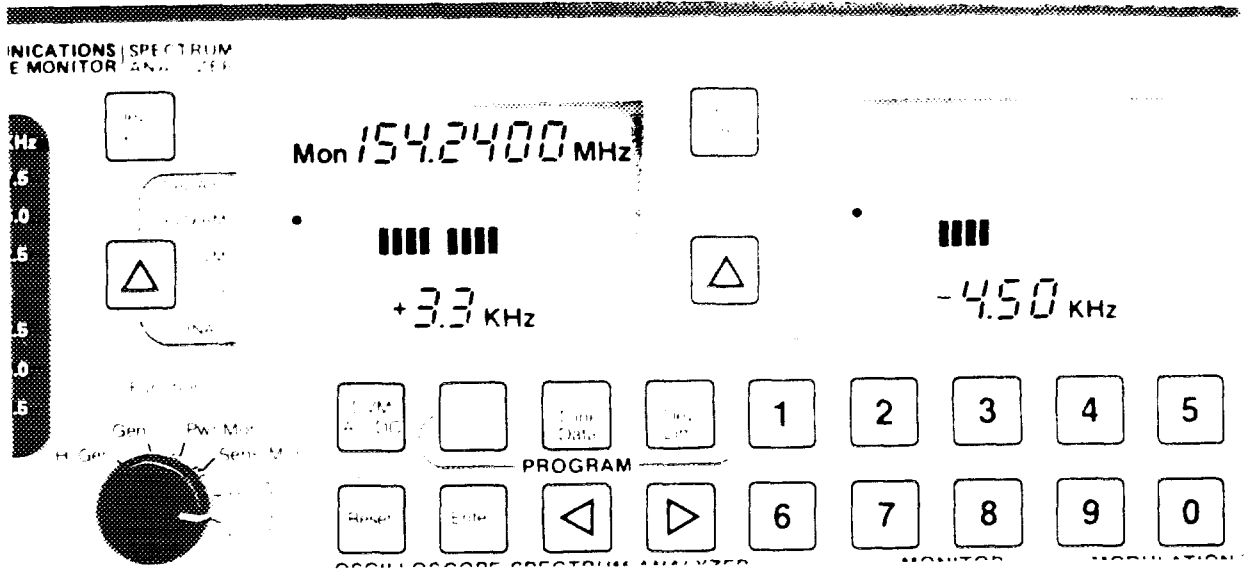

FIGURE 3-2—CLOSE-UP OF LCD'S AND MEMBRANE KEYBOARD

3.4.0 PROGRAMMING SEQUENCE

The unit has three program keys, **Freq**, **Tone Data** and **Dev Lim**.

Depressing any key will initiate the user programming states as detailed below. The left and right vertical cursors for LCD measurement displays and the vertical cursor in the modulation section will not respond whenever the unit is in a data entry state. When in any programming sequence, only numeric digits 0-9,

Enter, **Reset** and left and right cursors respond.

3.4.1 GENERATOR AND MONITOR FREQUENCY

The service monitor has the capability of storing a separate frequency for monitor and generate. To program the monitor frequency, set the function switch to "Pwr Mon" or "Sens Mon" ("Anlzd Pwr Mon" or "Anlzd Sens Mon" can also be used on the R-2400).

To enter an RF frequency press the **Freq** program key.

Immediately the first digit on the left LCD will blink indicating the point of entry. Next enter the desired frequency. Resolution is specified at 100 Hz on frequencies to 999.9999 MHz meaning seven decimal digits are valid entries. As the 7 digits are entered using the keys 0 through 9, the blinking cursor moves to the right automatically but may also be manually moved using the **▶** right or **◀** left cursors. To clear the entire entry, press **Reset**, if the **Reset** key is immediately depressed a second time, the original number stored in memory is displayed and the programming sequence is terminated. Pressing **Enter** loads the frequency and also leaves the frequency programming mode.

For example if a frequency 195.050 MHz is present in the left LCD display, an RF monitor frequency 455.321 MHz can be entered into the non volatile memory as:

Press Numeric Key	Press Program Key	Display	Comment
	Freq	190.050	
4		490.050	
5		450.050	
6		456.060	
	◀	456.060	Manually Correct Entry
5		455.060	
321		455.321	Complete Entry
	Enter	455.321	

NOTE: Shaded area indicates flashing digit. (point of data entry)

The monitor RF frequency is now stored. The same sequence is used to program the generator RF frequency, except the function switch should be set to the "Gen" or "Hi Gen" position.

3.4.1.1 FREQUENCY COPYING If the desired generator frequency is to be the same as the programmed monitor frequency, it is not necessary to enter the frequency twice. The frequency copy mode can be used as follows:

Press Program Key	Display	Comment
	455.3210	Displays monitor frequency
	(previously stored generator frequency now displayed)	Set function switch to Gen or Hi Gen
	455.3210	Displays monitor frequency again.
	455.3210	Generator frequency is now 455.3210

NOTE: Shaded area indicates flashing digit. (point of data entry)

The programmed generator is now the same as the monitor frequency. In a similar manner, the monitor frequency can be copied from the stored generator frequency.

3.4.1.2 FREQUENCY STEPPING Frequency stepping can be accomplished by using the and key. First, enter the frequency programming mode by pressing the key. The flashing digit can now be decremented using the key or incremented using the key. Even while the digit is flashing, the frequency indicated on the display is the actual operating frequency. It is not necessary to press every time a change is made. Frequencies are not stored in non-volatile memory, however, until is pressed. The and keys are used to position the flashing cursor as desired.

Press Program Key	Display	Comment
	455.3210	frequency in memory
	455.3210	reposition flashing digit
	455.3210	
	455.3210	
	455.4210	100 kHz increment
	455.5210	100 kHz increment
	455.4210	100 kHz decrement
	455.4210	flashing ceases exit program mode

NOTE: Shaded area indicates flashing digit. (point of data entry)

3.4.2 DEVIATION LIMIT

The deviation alarm is set in a similar manner to frequency. Start by pressing . The unit automatically switches the left LCD display to view deviation alarm information. The limit may take values between 00.0 and 99.9 kHz with 00.0 being a disable. As the 3 digits are entered using keys 0 through 9, the blinking cursor moves to the right automatically but may be manually moved using the right or left cursors. To clear the entire entry, press . If the key is immediately depressed a second time, the original number stored in memory is displayed and the programming sequence is terminated. The deviation alarm is provided to warn of FM deviation levels above this preset maximum and is active in any measurement mode provided the function switch is in the "SENS MON" or "PWR MON" position for FM type carriers. Press to load the programmed deviation limit. Once loaded, the left LCD display immediately returns to the measurement mode selected prior to programming.

NOTE: While programming the deviation limit, the function is inactive.

For example, if a deviation limit 00.0 KHz is present, a deviation limit of 5.5 KHz can be entered into nonvolatile memory as:

Press Numeric Key	Press Program Key	Display	Comment
		9.65 VAC	Previous Measurement Mode Selected
		00.0 KHz	
055		05.5 KHz	
		9.65 VAC	Prior Selected Mode

NOTE: Shaded area indicates flashing digit. (point of data entry)

3.4.3 TONE DATA

Once a tone data sequence has been started by pressing the vertical cursors on the left and right LCD's will not respond until the data entry sequence is completed. Programmed sequences of prompts, displayed in the upper portion of the right LCD, vary for modulation modes selected in the multimode code synthesizer. Depressing begins the sequences as follows:

3.4.3.1 PL The "PL" position is provided for PL tone outputs. The left side of the display will show the prompt "PL" and the right side will show the PL frequency last programmed. The PL tone may take on values of 50 Hz to 999.0 Hz. Enter the frequency starting with the blinking cursor position and press to load.

For example, to program a PL code of 150.7 Hz:

Press Numeric Key	Press Program Key	Display	Comment
			Select "PL" Modulation Mode
		223.6 Hz	Prior Programmed Code
1507		150.7 Hz	

NOTE: Shaded area indicates flashing digit. (point of data entry)

3.4.3.2 DPL, IDPL (inverted DPL) The "DPL" position is provided for DPL encode capability. The left side of the

display will show the prompt "DPL" and the right side will show the code last programmed. The code may take on values from 000 to 777 octal. Enter the code starting with the blinking cursor position and press to load.

If digits 8 or 9 are pressed before the key is depressed, they will be ignored by the unit because they are invalid entries.

For example, to program a DIGITAL PRIVATE LINE code of 350 octal:

Press Numeric Key	Press Program Key	Display	Comment
			Select "DPL" Modulation Code
		270	Prior Selected Code
250		250	Incorrect Entry
		250	Move Cursor to First Digit To Correct Entry
350		350	

NOTE: Shaded area indicates flashing digit. (point of data entry)

NOTE: All other sequences have frequency ranges between 50 Hz and 9999 Hz. The **maximum** number of digits accepted is four. This means if a frequency such as 1999.9 is entered, the unit will automatically put a zero in the least significant digit and you will get 9999.0



3.4.3.3 A The "A" position is provided for single tone outputs. The left side of the display will show the prompt "A FREQ" and the right side will show the frequency last programmed. Enter the frequency starting with the blinking cursor position. Press to load.

For example, to program a tone frequency of 2325 Hz.





Press Numeric Key	Press Program Key	Display	Comment
			Select "A" Modulation Code
		1950 Hz	Prior Selected Tone
2325		2325 Hz	

NOTE: Shaded area indicates flashing digit. (point of data entry)

3.4.3.4 B Same form as A



3.4.3.5 A/B T&V This sequence is for standard Motorola 2-tone paging. All timing is preprogrammed via software. The prompt sequence is the "A FREQ" followed immediately by the "B FREQ". First enter the A frequency in the blinking cursor position. Once the frequency is loaded, press , the unit will immediately provide the "B FREQ" prompt. Enter the B frequency and press  to load.







For example, program a paging sequence for Motorola two-tone paging formats using frequency 147.2 Hz and 227.5 Hz as:

Press Numeric Key	Press Program Key	Display	Comment
			Select "A/B T&V"
		225.6 Hz	Old "A" Frequency Is Displayed
1472		147.2 Hz	
		254.4 Hz	Old "B" Frequency Is Displayed
2275		227.5 Hz	



NOTE: Shaded area is flashing digit. (point of data entry)

3.4.3.6 A/B VAR This sequence is for other 2-tone paging codes for which the software provides six sequential prompts before the programming is complete.

- "A FREQ" as above.
- "B FREQ" as above.
- The "A DUR" (duration) prompt allows the timing of the first paging tone to be set in the range of 0.00 to 9.99 seconds. Enter the time and press  to load.
- The "B DUR" time is set in the same manner.
- The "A DLY" (delay) prompt allows the interdigit time to be set in the range of 0.00 to 9.99 seconds. Enter the time and press  to load.
- The "B DLY" time is set in the same manner and is the delay time between the end of TONE B and the repeat of TONE A.

Press Numeric Key	Press Program Key	Display	Comment
			Select "A/B" Var Modulation Code
		284.8 Hz	Old "A" Frequency Is Displayed
1366		136.6 Hz	
		174.5 Hz	Old "B" Frequency Is Displayed
1950		195.0 Hz	
		0.50 Sec	Old "A" Tone Duration
			Leave At 0.50 Seconds
		0.50 Sec	Old "B" Tone Duration
025		0.25 Sec	
		0.30 Sec	Old Interdigit Time
000		0.00 Sec	
		5.00 Sec	Old Repeat Cycle Time
			Leave At Same Recycle Rate

NOTE: Shaded area indicates flashing digit. (point of data entry)

3.4.3.7 TONE REMOTE This sequence is for console to base control using standard Motorola tone remote control. All timing and level changes are preprogrammed via software. The prompt sequence is started by pressing . The first prompt displayed is "A FREQ" for Hi and Low Guard (normally 2175 Hz) tone. Program the frequency using the numbered membrane keys, depress the  key to load. The "B FREQ" prompt follows and the same key strokes to enter a function tone are required. For example, program a Motorola tone remote control sequence of 2175 Hz guard tone and 1950 function tone as:

Press Numeric Key	Press Program Key	Display	Comment
			Select "Tone Remote" Modulation Code
	Tone Data	2175 Hz	Old High Guard Tone
	Enter		Leave At 2175 Hz
		1750 Hz	Old Function Tone
1950	Enter	1950 Hz	

NOTE: Shaded area indicates flashing cursor. (point of data entry)

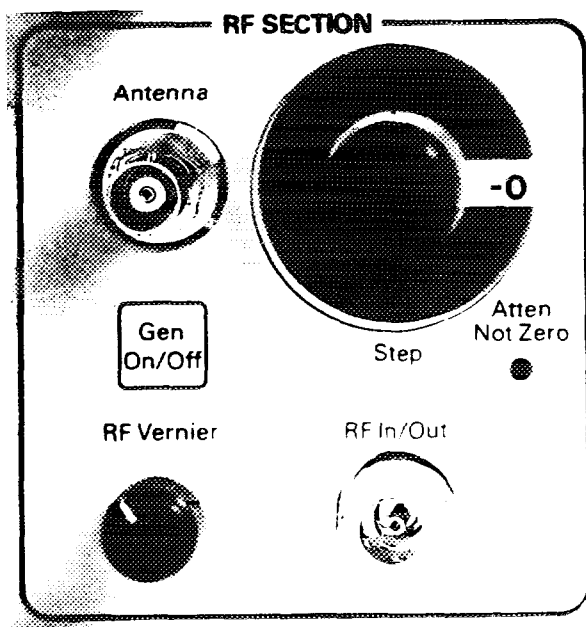

FIGURE 3-3—RF SECTION CLOSEUP

NOTE: There are two memory positions dedicated to the A frequency and B frequency. If an operator changes the A frequency or B frequency in any code synthesizer mode, that same frequency change will appear in all modes.

3.4.4 CANCELLING ENTRIES To cancel the entire entry when partially completed press **Reset** **Reset**. The first "RESET" always recalls the previously stored number and returns the cursor to the first digit. **Reset** **Reset** recalls the old number and terminates the programming mode. Any parameter entered completely during the earlier part of the sequence will retain its new value. Only the parameter currently being entered will revert to its previous state.

3.5.0 RF SECTION

3.5.1 RF IN/OUT CONNECTOR

A type N connector is provided and allows the service monitor to measure the RF output of the radio under test in the "Pwr Mon" function (.5 to 125 watts). The R-2400 will display the spectrum of the signal when "Anlzf Pwr Mon" is used. In the "Gen" mode, the RF output from the type N connector will be in the .1uV to 200uV range.

CAUTION: Do not apply RF power when unit is on "OFF" or "STANDBY" mode. The unit must be powered for the protective circuitry to operate.

3.5.2 ANTENNA

A BNC connector is provided for RF input in the "Sens Mon" (sensitive monitor) mode with a 1.5uV sensitivity. The R-2400 will display the spectrum of the monitored signal when the "Anlzf Sens Mon" function is used. An RF signal in the range of 200uV to 1V RMS is output from the BNC connector when in the "Hi Gen" (hi generate) mode. This connector is fuse (P/N 6580377A61) protected against inadvertently keying the radio under test while connected to the input. The fuse is inside this connector and is accessible by unscrewing the connector from the front using a hex wrench. If the unit exhibits the symptoms of no "HI GEN" output and very poor off-the-air receive sensitivity, this fuse may require replacement.

3.5.3 STEP ATTENUATOR

An eight position rotary switch attenuator is provided, calibrated in 10 dB steps for control of outgoing RF level and for attenuation of received or monitored signals.

3.5.4 RF VERNIER

A potentiometer type vernier control adjusts the RF output level when generating an RF signal.

3.5.5 GEN ON/OFF

A special switch is available to turn off the RF output generated by the service monitor in the "GEN" (generate) or "HI GEN" (high generate) functions. This is useful for testing where the presence or absence of carrier needs to be selected easily, such as in 20 dB quieting checks. The generator is always reenabled when the "FUNCTION SWITCH" is moved from a monitor function to a generate function or when the microphone Push-to-Talk is energized.

3.5.6 ATTEN NOT ZERO

An LED illuminates as a reminder that the RF attenuator control is not in the zero position, and the receiver is not at maximum sensitivity.

3.6.0 OSCILLOSCOPE/SPECTRUM ANALYZER/MODULATION SCOPE SECTION

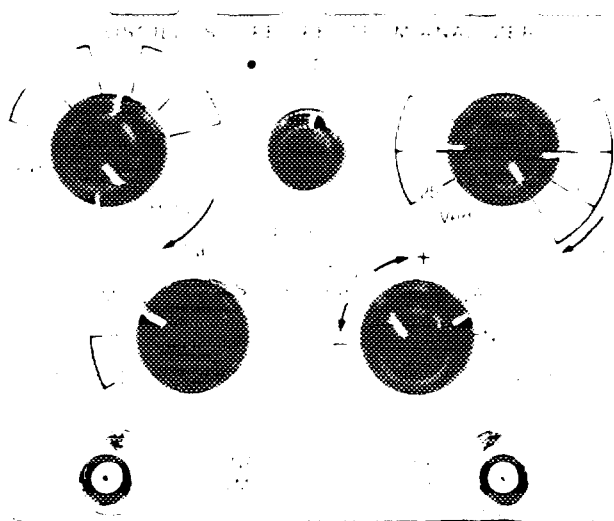

FIGURE 3-4—CLOSEUP OF SCOPE CONTROLS

3.6.1 INTENSITY

The intensity control varies the brightness of the scope trace.

3.6.2 FOCUS

The focus control varies the sharpness of the scope trace.

3.6.3 HORIZ

This seven position rotary switch selects the horizontal sweep rate or the external horizontal sweep input when the oscilloscope function is being used. On the R-2400, this same control is used to select the dispersions of 1, .1, and .01 MHz/div when the spectrum analyzer function is selected with the function switch. The sweep rate is automatically fixed when in the spectrum analyzer mode.

3.6.4 HORIZ VERNIER

This potentiometer controls the horizontal sweep rate when the oscilloscope functions is being used. The calibrated position is the fully clockwise position. This control is disabled when the R-2400 spectrum analyzer function is being used.

3.6.5 SOURCE

The source control is a three position rotary switch which selects the source for the scope vertical input. "MOD" (modulation) will display the outgoing RF modulation signal or the recovered modulation signal. The "EXT AC" (external AC) position selects AC coupled external input from the BNC connector. The "EXT DC" (external DC) position selects the DC coupled external input from the same BNC connector.

3.6.6 VERT

A four position rotary switch controls the vertical display. Oscilloscope operation uses values marked to the right of the switch indicating volts per division. Values marked to the left of the switch are used when modulation is displayed on the oscilloscope. The right bezel of the oscilloscope has a numerical scale corresponding to values of .25 kHz, 2.5 kHz and 25 kHz per division. This allows deviation measurements to be made even when the service monitor LCD display is not selected to "DEV/%AM" and gives the technician the ability to detect non-symmetric modulation. This switch is disabled when the R-2400 spectrum analyzer is being used.

3.6.7 VERT VERNIER

The vertical vernier potentiometer controls the vertical inputs to the oscilloscope. The calibrated position is fully clockwise.

NOTE: The vertical vernier potentiometer is also functional when the R-2400 spectrum analyzer mode is being used. It is important to have this control in the "Cal" position to ensure true 10dB/div vertical accuracy.

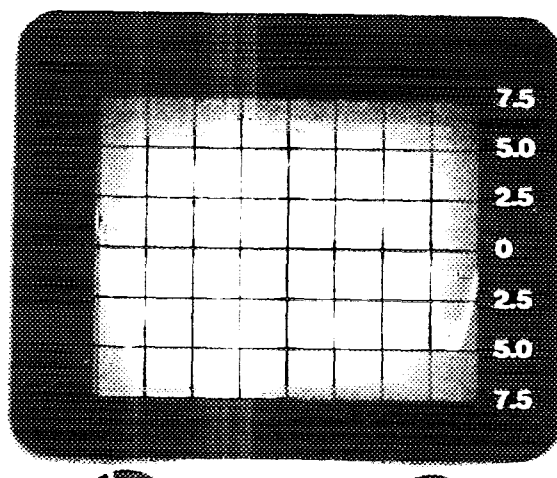

FIGURE 3-5—CLOSEUP OF SCOPE TRACE

3.6.8 POSITION

The stacked concentric potentiometers control the vertical and horizontal positions of the scope trace.

For R-2400 spectrum analyzer operation, these controls are also used to center the observed spectrum. When entering the spectrum analyzer mode, use the "Vert Position" control (innermost control) to set the base of the noise floor at the bottom graticule. The Horiz Position control is adjusted by first programming for an RF frequency of 000.0000 Mhz (dc reference), then with the dispersion control set for 1Mhz/div, use the Horiz Position control (outermost potentiometer) to center the observed spectrum display horizontally around the center (5th) vertical graticule.

3.6.9 TRIG MODE

The triggering mode is a three position rotary switch and selects the scope triggering mode or can turn the scope off to save power. "AUTO" (automatic) provides a continuous sweep with no vertical input. The "NORM" (normal) position requires an external vertical input to trigger a sweep. The "SCOPE OFF" position turns off the scope. This will extend battery operating time.

3.6.10 TRIG LEVEL

The triggering level potentiometer adjusts the scope trigger voltage.

3.6.11 VERT/SINAD/DIST DVM

Multi-purpose input. Also located in the oscilloscope section is a BNC connector to connect signals to the unit for the following functions:

1. External vertical inputs for oscilloscope operation. Sensitivity ranges from 10 mV/div to 10 V/div.
2. SINAD meter input range is .5 V to 10 VRMS.
3. Distortion meter input range is .5 V to 10 VRMS.
4. Digital Volt Meter input. Accepts AC and DC voltages and provides 3 digit autoranging scales of 1,10,100 and 300 volts full scale.

NOTE: An extreme overload condition to the oscilloscope could result in activating input protection circuitry which can induce reading errors on all measurement modes using the multipurpose input connector. This will only occur with the oscilloscope vertical input sensitivity set much too sensitive for the signal being measured, and the viewed oscilloscope signal is obviously overloading and deflecting far off-screen.

3.7.0 MONITOR SECTION

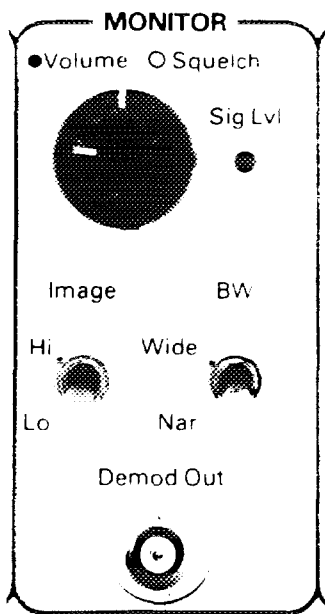

FIGURE 3.6—CLOSEUP OF MONITOR SECTION

3.7.1 VOLUME/SQUELCH The volume control adjusts the speaker output level. The squelch control adjusts the threshold level. Full counter clockwise disables the squelch.

NOTE: Monitor sensitivity is greatly decreased as the squelch control is increased clockwise beyond the no-squelch squelch point.

3.7.2 IMAGE HI/LO

In either monitor mode this toggle switch selects the frequency of the local oscillator injection above or below the programmed monitor frequency to remove image interference. The normal position is "LO". When a signal unsquelches the receiver, flipping the switch to "HIGH" will verify that the signal being monitored is at the programmed frequency and not a receiver mixing image. This switch is also used to identify images when the R-2400 spectrum analyzer is being used.

3.7.3 BANDWIDTH WIDE/NARROW

In either "PWR MON" or "SENS MON" functions this switch selects the IF bandwidth. Narrow band is ± 10 kHz modulation acceptance used for most 2-way radio communication systems and wide band is ± 75 kHz modulation acceptance used for commercial FM broadcast monitoring or locating a signal when the exact frequency is not known.

3.7.4 DEMOD OUT

The demod out BNC connector provides receiver audio output. Output signals can be used for transmitter distortion measurements or for external frequency counters.

3.8.0 MODULATION SECTION

3.8.1 GENERAL

The multimode code synthesizer contains all controls used to generate an audio signal. Starting with a sinusoidal one kilohertz tone oscillator, the section also includes capability to modulate a carrier with PL,DPL,IDPL, single tone or two tone paging type signalling. A four pin microphone connector is available for voice modulation and a BNC connector is available for input from an external signal generator. An important feature is the capability to do **simultaneous** modulation. It is possible to combine voice, any single code available from the code synthesizer and a 1 kHz test tone in order to provide composite signals for complete testing.

3.8.2 1 KHz LEVEL

An internal 1 kHz tone modulation level control is provided. When in the full counterclockwise position the 1 kHz source is disabled. Modulation levels can be viewed by selecting "Dev/% AM" on the left LCD and operates in any selected function switch position.

3.8.3 EXT MOD IN

A BNC connector is provided for external modulation signal inputs.

3.8.4 MIC CONNECTOR

A 4-pin connector is provided with microphone bias and PTT capability. Depressing the PTT button on the microphone is the same as changing the FUNCTION switch.

Function With PTT Open	Function With PTT Depressed
HI GEN	HI GEN
GEN	GEN
PWR MON	GEN
SENS MON	HI GEN

The mic input contains a deviation limiter to limit voice modulation peaks as in a mobile radio.

3.8.5 EXT LEVEL

Control of the microphone and other external signal generators modulation level is provided. When in the full counter clockwise position, the source is disabled. Modulation levels are viewed by selecting the "DEV/% AM" display on the left LCD and can also be viewed on the modulation scope.

3.8.6 CODE-SYNTHESIZER LEVEL

The potentiometer controls the internal code synthesizer modulation level. When in the full counterclockwise position, a minimum modulation level is reached. ON/OFF control is provided by the modulation switch. Modulation levels are viewed by selecting the "DEV/% AM" display on the left LCD and can be viewed on the modulation scope. Also the code synthesizer operates independently of the function switch setting.

3.8.7 MODULATION SWITCH

A 3 position toggle switch controls the code synthesizer modulation source.

1. Cont.—Allows continuous modulation (recycle) signal outputs. Sequential tone patterns will be repeated as long as this switch is enabled.
2. OFF—Turns off the modulation signal. If in the DPL or IDPL mode, returning the switch to the OFF from continuous or burst produces a 134.4 Hz stop tone burst for 120 ms.
3. Burst—For PL, tone A and tone B modes the output is present for as long as the switch is held in the burst position. For A/B Var, A/B T&V, and tone remote, putting the switch in the Burst position causes one cycle to be output. For tone remote, the last A tone is output for as long as the switch is held in the burst position to simulate low guard tone. In the DPL or IDPL modulation mode the burst position causes continuous cycling of the code as long as the switch is depressed. When the switch is released the code completes the cycle it was in and a 120 ms burst of stop tone (134.4 Hz) is generated.

3.8.8 CODE SYNTHESIZER MODE SELECTION

The code synthesizer provides capability to select any of the formats listed below. Each of 10 positions has a corresponding LED to indicate which mode is selected. Only when the modulation switch is toggled away from the off position will the outputs be generated and displayed in the right LCD. The modulation switch must be active for setting deviation with the code synthesizer level control. Positioning of the selected mode is performed by the Δ vertical display cursor. As with all cursor controls in the unit, an audible feedback tone will verify acceptance of a switch activation.

1. PL COUNT—Code synthesizer outputs programmed PRIVATE LINE frequency, displays counted frequency of incoming PL tones if in either monitor function.
2. PL—Programmed PRIVATE LINE frequencies to 1 kHz.
3. DPL—Programmed DIGITAL PRIVATE LINE codes are output

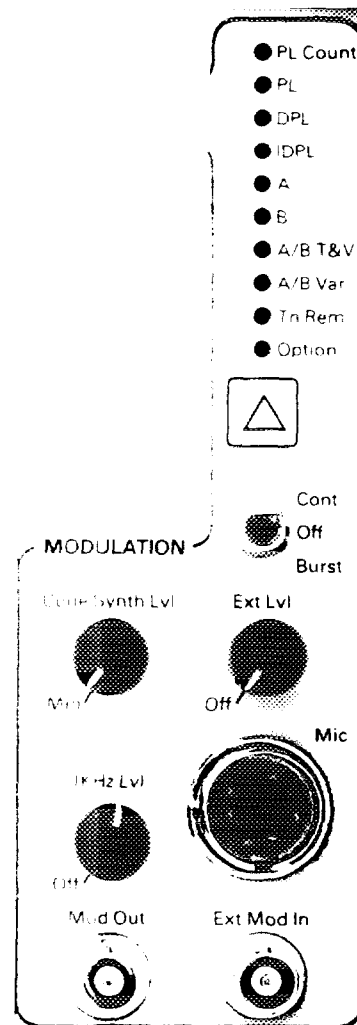

FIGURE 3.7—CLOSEUP OF MODULATION SECTION

4. IDPL—Inverted output of programmed DIGITAL PRIVATE LINE code is selected for output.
5. A—Tone A is selected for output.
6. B—Tone B is selected for output.
7. A/B T&V—Indicates that A/B tone and voice paging sequence has been selected for output.
8. A/B VAR—Indicates that A/B sequence with variable programmed values for duration and delays has been selected for output.
9. TN REM—Indicates access sequence for Motorola tone remote control has been selected.
10. OPTION—This mode is reserved for future expansion. Without an option card installed, this mode cannot be selected. SEE PARAGRAPH 3.10.0

3.9.0 REAR PANEL CONTROLS

3.9.1 BATTERY/EXT DC

If turned on, the service monitor will automatically switch to battery power if no AC source is available and the unit is equipped with the battery option. When the switch is in "EXT DC" allows the unit to be powered by an external voltage source such as a car battery.

3.9.2 DC IN

A 4-pin power connector to connect the unit to a DC prime power source. A connector is provided.

3.9.3 AC 1.1A

AC line fuseholder. (spare fuse provided 65-00042092)

3.9.4 DC 8A

DC prime power source fuseholder. (spare fuse provided 65-80397A22)

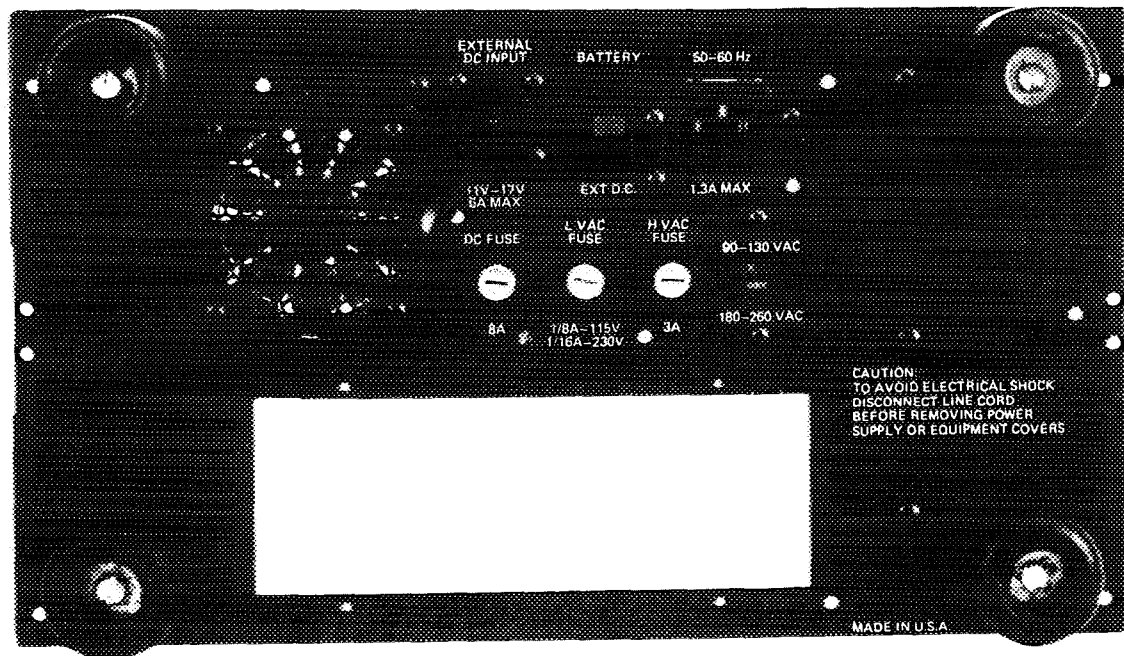

FIGURE 3-8—REARVIEW

3.10.0 TWO-WAY SERVICE OPTION OPERATING SYSTEM

Being the first in a series, the Two-Way Service Option card is structured with a unique operating system which uses a list of numeric commands to accommodate the numerous signalling variables found in the land mobile industry signalling standards. This operating system requires the operator to first select the *OPTION* position within the code synthesizer section of the R-2200. The following paragraphs detail how the operator accesses these unique functions.

The functions of the R-2200 provided by the Two-Way Service Option, RTL-4161A, are accessed via a special set of Function Codes. Each mode of operation has a unique code which must be entered by the operator. These Function Codes are listed below.

OPTION CODE	FUNCTION
1 1	DPL Decode
1 2	Inverted DPL Decode
2 1	DTMF Decode
3 1	DTMF Batch Encode Timing — Tone Duration and Delay (Default = 100 ms on, 50 ms off)
3 2	PL Frequency Select for simul PL and DTMF Encode
3 3	DTMF Manual Encode without PL
3 4	DTMF Batch Encode without PL
3 5	DTMF Manual Encode with PL
3 6	DTMF Batch Encode with PL

3.10.1 DPL/IDPL DECODE

This sequence is for any DPL (DIGITAL PRIVATE LINE) or Inverted DPL (IDPL) decoding. The DPL or IDPL modes of operation are accessed by first selecting the *OPTION* position of the code synthesizer.

3.10.1.1 DPL DECODE—ACCESS CODE 1 1

Press Numeric Key	Press Program Key	Display	Comment
1 1		dPL - - -	Ready to decode DPL
		4 1	Current state of NV memory.

NOTE: Shaded area indicates flashing digit. (point of data entry)

3.10.1.2 IDPL DECODE—ACCESS CODE 1 2









Press Numeric Key	Press Program Key	Display	Comment
1 2		dPL - - -	Ready to decode IDPL
		4 1	Current state of NV memory.

NOTE: Shaded area indicates flashing digit. (point of data entry)

3.10.2 DTMF DECODE

This sequence allows decoding of the standard 16 DTMF tone pairs. Decoding of DTMF tone pairs is functional from 3 different sources. The decoder will function OFF-THE-AIR, with a direct radio connection or from the External Modulation In BNC connector (EXT MOD), located in the Modulation Section of the R-2200 front panel. The Function Switch must be in the "Gen" or "Hi Gen" position to decode DTMF tones via the External Modulation BNC connector. DTMF decoding modes of operation include a BATCH DECODE mode. When a series of DTMF digits must be decoded, a maximum of 16 digits can be decoded and stored in memory.

3.10.2.1 DTMF BATCH DECODE—ACCESS CODE 2 1



Press Numeric Key	Press Program Key	Display	Comment
		31	Current state of NV memory.
2 1		dFd - - -	Place MODULATION SWITCH in "CONT" and the unit is ready to decode DTMF
			When finished decoding DTMF tone pairs, place Modulation Switch in "OFF" position.
		dFd 123	Using right cursor, review code stored in NV memory.
		≡1234	"dFd" has now scrolled off the LCD display.
		≡12345	Scrolling through memory
		1234567	A total of 7 digits maximum can be displayed at a single time.
		234567≡	End of decoded sequence is now reached.
	 or 	1234567	Backspace using left cursor or press Reset.
		dFd - - -	Place MODULATION SWITCH in CONT to clear display and ready for another decoding sequence.

NOTE: Shaded area indicates flashing digit. (point of data entry)

3.10.3 DTMF ENCODING

The Two-Way Service Option includes 4 different and distinct methods of encoding DTMF signalling tone pairs. As mentioned previously, the option card is capable of encoding DTMF, 1) Manual with PL, 2) Manual without PL, 3) Batch with PL and 4) Batch without PL. Begin by selecting the OPTION position of the code synthesizer.

3.10.3.1 DTMF REAL TIME ENCODING—ACCESS CODE 3 3

Press Numeric Key	Press Program Key	Display	Comment
		34	Current state of NV memory
3	3 	dFE	Now in Real Time DTMF Encode Mode
4		dFE 4	Place MOD switch in CONT and set Deviation to 3.3 KHz
2		dFE 2	Now generating DTMF Key 2 Place Mod switch in OFF Place Mod switch in BURST. DTMF Key 2 is sent with a tone on 100 mS (default) or per timing instructions entered in User Defined DTMF Encode mode. ie. Access Code 3 1
		dFE _	Flashing underscore Ready to enter special character DTMF key.
6		dFE P	Ready to send "*" DTMF key either continuously or for 100 mS. (ie. use MOD switch)













NOTE: If modulation switch is placed in "CONT" tone be sent continuous

If modulation switch is placed in "OFF" tone will be sent when digit key is pressed or when ENTER key is pressed. ENTER key is used for special character tones of "*" and "#".

If modulation switch is placed in "BURST" the displayed digit is sent per the default timing (100 ms Tone ON, 50 ms Tone Off) or the operator defined timing parameters (OPTION CODE 3 1).

NOTE: Shaded area indicates flashing digit. (point of data entry)

3.10.3.2 DTMF BATCH ENCODER NO PL—ACCESS CODE 3 4

Press Numeric Key	Press Program Key	Display	Comment
		3 1	Current state of NV memory
3	4 	dFE 123	LCD display shows first three DTMF characters stored in NV memory
		dFE 123	Enter EDIT mode
		dFE 123	Moving flashing cursor to review code stored in NV memory
		dFE 123	
		≡ 1234	"dFE" has now scrolled off the LCD display.
		≡ 12345	
		≡ 12345	Reached end of stored code in NV memory and can enter new data or backspace using  and edit.
		≡ 12345 ≡	Ready to enter special DTMF character
	5 	≡ 12345F	Have loaded "*" DTMF key into NV memory.
		≡ 12345F ≡	Ready to terminate DTMF EDIT mode.
		dFE 123	Stored DTMF code is now "12345F"

Place MODULATION switch in CONT. Entire sequence of 12345* is sent, or BURST position to send digits one at a time.

NOTE: Shaded area indicates flashing digit. (point of data entry)

NOTE: User can review NV memory when out of edit mode by using cursors. No digits are flashing and the end of NV memory is indicated by " " end of data marker.

3.10.3.3 USER DEFINED DTMF ENCODER TIMING — ACCESS CODE 3 1

Press Numeric Key	Press Program Key	Display	Comment
		3 4	Current state of NV memory
3 1		0.05 sec	Old Tone On time displayed. Set duration time to 350 ms (next step)
035		0.15 sec	Old Tone Off Time Set interdigital time to 150 ms (next step)
015		3 1	Ready to select DTMF Encode mode

NOTE: Normal DTMF Batch Encode procedure can be followed from this point. Timing parameters entered in this mode will be carried over into all DTMF encoding modes of operation.

3.10.3.4 PL FREQUENCY SELECT — ACCESS CODE 3 2

Press Numeric Key	Press Program Key	Display	Comment
		3 1	Current state of NV memory
3 2		2 23.6 Hz	Prior Programmed Code
1507		3 2	Ready to select desired DTMF Encode Option Code

3.10.3.5 DTMF BATCH ENCODE WITH PL — ACCESS CODE 3 6

Press Numeric Key	Press Program Key	Display	Comment
		3 1	Current state of NV memory
3 6		dFE 123	First three DTMF characters are displayed

NOTE: Preset the required PL code (para. 3.10.3.4) before entering the Simultaneous PL & DTMF batch encoding mode. PL tones will automatically be superimposed on the DTMF with a preset deviation equal to 25% of the DTMF deviation level. Example: DTMF Deviation level = 3.2 KHz therefore PL Deviation level = 800 Hz.

NOTE: To access special character DTMF keys perform the following:

SPECIAL CHARACTER	OPERATOR ENTRY PROCEDURE
A	
B	
C	
D	
* (shown as "F" on LCD)	
# (shown as "P" on LCD)	

NOTE: To clear NV memory to end while in edit mode press

NOTE: Should the R-2200, with RTL4161A Signalling Option installed, appear to operate abnormally (for example - the unit may not operate in the batch encode mode, when in the option position), it may be the result of invalid data being stored in the non-volatile memory. A mode of operation has been included in the RTL4161A software that will reset the memory to a default status should this occur. This mode is accessed by entering the option code 9 2. The memory reset function should be performed before proceeding with any other troubleshooting procedure.

NOTE: The RPN-4309A kit is available on a field retrofit basis for any R-2200 or R-2400 already shipped without the two-way service option installed. This kit contains the two-way service option board and all necessary instructions to properly install it.

SECTION 4

OPERATING INSTRUCTIONS

4.1.0 OPERATION

The operator may use the LCD's and CRT display to become familiar with the functions the Communication Service Monitor is capable of performing. As a function is selected, its parameters are displayed on the LCD's.

4.2.0 POWER UP

4.2.1 PARAMETER MEMORY

The unit contains nonvolatile memory that stores the most recently programmed values for the following parameters;

1. Operating Frequency
2. DPL Code
3. PL Frequency
4. Tone A and B
 - a) Frequency
 - b) Duration
 - c) Delay
5. Deviation Alarm Limit

Also included in memory are the most recent state of the following membrane keys;

1. DEV \pm
2. RF V/dBm
3. Display select arrows (left and right)
4. DVM AC/DC
5. Code Synthesizer Modulation select arrow (vertical)

WARNING Lithium Battery

The processor module within this system utilizes a lithium battery as a memory keep-alive voltage source. Do not mutilate or disassemble the battery cell. The lithium metal is a very active material that burns in the presence of water or high humidity. Do not put the battery in fire, attempt to charge, heat above 100°C, or solder directly to the cell. Do not overdischarge the cell to a reverse voltage greater than 3 volts. The battery may burst and burn or release hazardous materials.

CAUTION Lithium Battery

Lithium batteries are classified as hazardous materials and must be disposed of accordingly. Do not dispose of the battery by placing it in with the everyday trash. Consult state and local codes for the appropriate disposal procedure. Motorola will dispose of the battery if the expended battery is returned in the replacement battery container and by the same method that the new battery came to you, send to: Motorola Inc., Return Goods Department, 1313 East Algonquin Road, Schaumburg, Ill. 60196.

4.2.2 DEFAULT PARAMETERS

The unit will initialize to the last active state unless the battery (P/N 60-83294N03) which powers the non-volatile memory is faulty or has low output level due to age or defect. (See the maintenance manual for battery replacement.) Should this occur the initialized parameter values will be;

Operating Frequency-100 MHz

DPL Code-000

PL Frequency-100 Hz

Tone A

a) Frequency-1 kHz

b) Duration-0.5 Sec

c) Delay-0.0 Sec

Tone B

a) Frequency-1.5 kHz

b) Duration-0.5 Sec

c) Delay-0.0 Sec

Deviation Alarm Limit-0.0 kHz (alarm off)

DEV \pm initial state is +

RF V/dBm initial state is Volts

Display Select (left) initial state is SINAD

Display Select (right) initial state is RF LVL or RF PWR

DVM AC/DC initial state is AC

Code Synthesizer Modulation select initial state is TN REM

NOTE: The Lithium Battery used for non-volatile memory is included in every unit and is independent of the optional RTP-4021A Battery Pack Option.

All functions that are controlled by toggle switches, rotary switches or potentiometers are initialized according to the current positions of the switches.

4.3.0 GENERATE OPERATION

The Service Monitor generates RF frequencies for FM, AM, and CW transmissions covering a range of 200 kHz to 1 GHz. To generate a signal the "FUNCTION" switch is placed in the "GEN" or "HI GEN" position.

NOTE: An RF protection circuit to protect against damage due to inadvertent application of RF power to the unit is provided.

4.3.1 OUTPUT LEVEL

Output in the "GEN" function is available at the "RF IN/OUT" connector. Voltage output range is .1 uV to 200 uV into 50 ohms for direct connection to the antenna input of the equipment under service. Output in the "HI GEN" function is available at the antenna BNC connector of the unit. Voltage output range is 200 uV to 1 VRMS. This is sufficient for transmission through an antenna connected to the antenna connector.

4.3.2 MODE SELECT

The modulation mode is selected using the "MODE" switch. AM, FM, and CW (no modulation) are available.

4.3.3 SIMULTANEOUS GENERATE AND MEASUREMENT OPERATION

The following test setups and LCD displays are examples of simultaneous generate and measurement operation.

1. Connect the RF In/Out to the mobile radio antenna connector and the multipurpose measurement input to the receiver audio output.
2. Set the function switch to GEN and Δ to Dev.
3. Enter the frequency by pressing

Freq	1	5	4	5	5	0	0	Enter
------	---	---	---	---	---	---	---	-------
4. Adjust the 1 KHz level for 3.0 KHz deviation and then move the cursor Δ to SINAD.
5. Adjust the RF venier for 12 dB SINAD indication.
6. Read the receiver sensitivity in microvolts or dBm.
7. Increase the RF generator level to 100 μ V.
8. Move the cursor Δ to Dist. Read the receiver distortion in %.
9. Move the cursor Δ to DVM.
10. Select AC or DC volts using

DVM
AC/DC

 switch. If oscilloscope display is desired select the proper external vertical trigger for oscilloscope display.
11. Apply test signals from the receiver audio stages to the unit's VERT/SINAD/DIST/DVM input. The same x1 test probe used for SINAD and Distortion may be used.
12. The voltage can be read on the left LCD display or viewed on the oscilloscope.

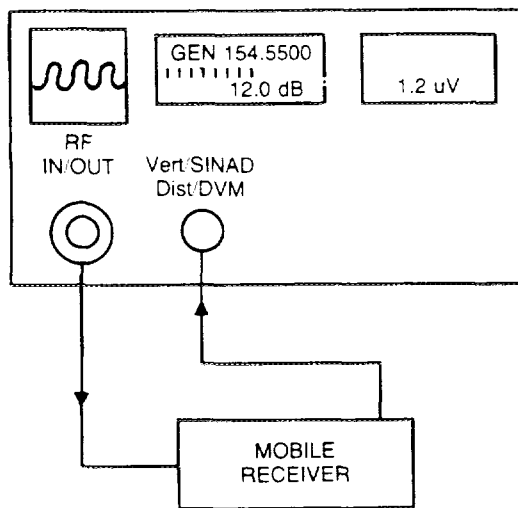

FIGURE 4-1—TEST SET-UP FOR FM RECEIVER SENSITIVITY

4.3.4 TEST PAGER DECODE AND ALERT FUNCTION

The internal programmable code synthesizer generates PRIVATE LINE (PL) AND DIGITAL PRIVATE LINE (DPL) squelch codes, two-tone sequential paging and base station tone remote control signal continuously or in burst cycles as an internal modulation source. In addition to the code synthesizer, modulation is simultaneously available from an independently adjustable internal 1 KHz tone generator as well as from external input sources.

1. Connect the pager test fixture to the RF In/Out Connector.
2. Set the FUNCTION switch to GEN and enter the frequency from key board.

Freq	1	5	4	5	5	0	0	Enter
------	---	---	---	---	---	---	---	-------

3. Select the paging format. Enter the pager tone code frequencies. Start by pressing

Tone
Data
4. Activate by placing the Code Synthesizer switch in the burst (momentary) or continuous position and adjust Code Synth Lvl for 3.3 KHz deviation. A functional pager will respond

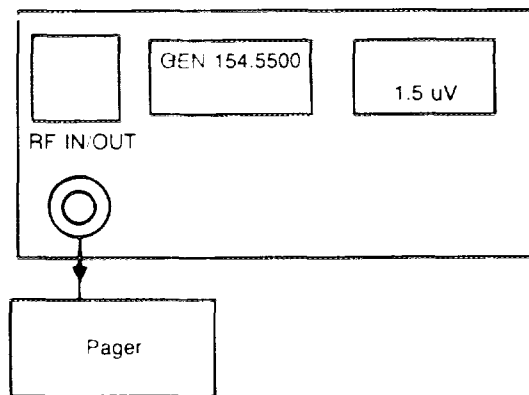

FIGURE 4-2—TEST SET-UP FOR PAGER AND ALERT FUNCTIONS

NOTE: A/B T&V has preprogrammed timing sequences for two-tone sequential tone and voice paging. A/B VAR is user programmable. Variable timing sequences are used for other signalling systems.

4.4.0 MONITOR OPERATION

4.4.1 SENS MON

The Service Monitor is capable of monitoring frequencies of 3 MHz to 1 GHz with 1.5 μ V sensitivity. The monitor may be used to 1 MHz with reduced sensitivity.

1. Connect the BNC antenna (TEKA-24A) to the antenna connector located in the RF section.
2. Set the FUNCTION switch to SENS MON.
3. Select the modulation type using the MODE switch.

4. Enter the frequency from the keyboard



5. Adjust the squelch and volume.
6. Move the left cursor Δ to Dev/AM. Move the right cursor Δ to frequency error. Listen to received audio from the internal speaker and view on the oscilloscope.

NOTE: The antenna input is fuse protected against inadvertent keyup into the antenna input. Consult the maintenance portion of the manual for fuse replacement. In either PWR MON or SENS MON functions the BANDWIDTH WIDE/NARROW switch selects the IF bandwidth. Narrow band is ± 15 KHz modulation acceptance used for most 2-way radio communication systems and wide band is ± 75 KHz modulation acceptance used for commercial FM broadcast monitoring.

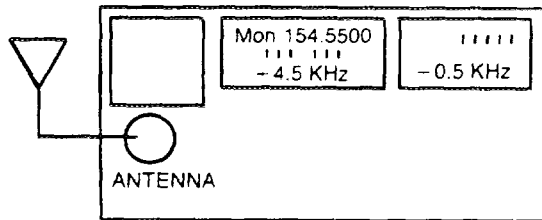

FIGURE 4-3—TEST SET-UP FOR OFF-THE-AIR MONITORING

CAUTION: Care should be taken to not exceed the .5 watt max. input level of the "Antenna Input".

4.4.1.1 SENS MON WITH SPECTRUM ANALYZER (R-2400 only)

1. Connect the BNC antenna to the "Antenna" connector located in the RF section.
2. Set the Function switch to "Anlzd Sens Mon".
3. Adjust the Vertical and Horizontal Position controls if necessary (see 3.6.8).
4. Ensure that "Vert Vernier" is set for "Cal".
5. Enter the RF frequency from the keyboard.



6. Adjust the squelch and volume.
7. Adjust for desired dispersion of .01 Mhz/div (see 3.6.3).
8. Adjust the RF step attenuator to give the desired signal level.
9. Check for the presence of images using the Image Hi/Lo switch (see 3.7.2).

4.4.2 PWR MON

For high power signal monitoring (.5 to 125 watts)

1. Connect the radio under test antenna out to the RF IN/OUT connector on the Service Monitor.
2. Set the FUNCTION switch to PWR MON.
3. Enter the frequency from keyboard.
4. Move the right cursor to PWR.
5. Key the radio under test and read output power.

CAUTION: To prevent undue stress on the protected circuits it is advisable to always switch the system to the power monitor before applying power in excess of 200 mw. Additional protection is also obtained by making it a practice not to leave the step attenuator in the 0 dB position.

High-powered equipment in the 1-30 MHz range, which have unusually fast carrier rise times, may damage the service monitor with repeated activation of the protect circuit. Ensure the FUNCTION switch is in the "PWR MON" position (this enables the protect circuit) before RF power is applied to the equipment.

In either monitor mode, the displays can be selected using vertical cursors to the left of each LCD to view frequency, frequency error, modulation level, distortion and power when in the PWR MON function for AM, FM or CW signals.

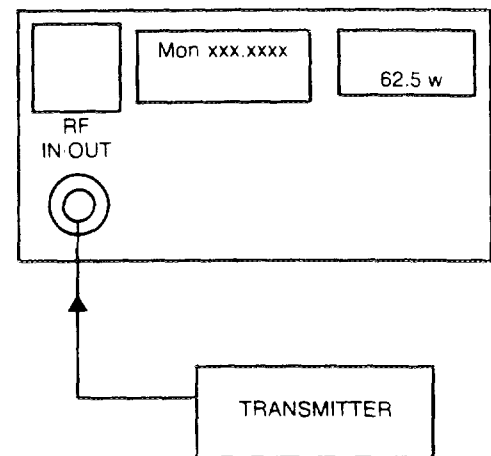

FIGURE 4-4—TEST SET-UP FOR POWER MEASUREMENT

4.4.2.1 PWR MON WITH SPECTRUM ANALYZER (R-2400 only)

For high power signal monitoring (.5 to 125 watts)

1. Connect the radio under test antenna out to the "RF In/Out" connector on the service monitor.
2. Set the function switch to "Anlzr Pwr Mon".
3. Adjust the Vertical and Horizontal position controls if necessary (see 3.6.8).
4. Enter the RF frequency from the keyboard.
5. Move the right cursor to "PWR".
6. Adjust the RF Step attenuator for maximum attenuation (70 dB)
7. Key the radio under test and adjust the RF step attenuator for the desired viewing level.
8. Read the output power on the LCD display.

4.4.3 TRANSMITTER DISTORTION MEASUREMENTS IN THE PWR MON FUNCTION

The distortion meter display can be viewed in either Generate or Monitor function. The distortion meter measures the quality of the audio.

1. Connect the RF IN/OUT to the radio antenna jack and connect the modulation output to the radio mic input. Connect the DEMOD output to the multipurpose input BNC connector. This allows the unit to be used as a test receiver.

2. Enter the RF Frequency



3. Set the function switch to Pwr Mon and Δ to Dist.
4. To display modulation waveforms of the transmitter turn the oscilloscope source switch to "MOD."
5. Adjust the 1 kHz tone level for proper deviation. (out of clipping) Disable PL if resident in the transmitter.
6. Read transmitter audio distortion in % on the digital readout. Note that transmitter power and frequency error can also be displayed on the right LCD.

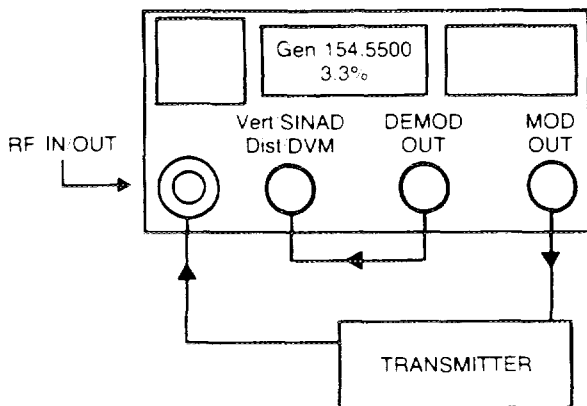

FIGURE 4-5—TEST SET-UP FOR TRANSMITTER DISTORTION MEASUREMENT

4.4.4 MEASUREMENT OF TRANSMITTED "PL" TONE

With the internal PL frequency counter it is possible to measure the PL tone of a transmitter. The function switch can be moved to either monitor function position.

1. Select the PL Count mode located in the modulation section using the Δ cursor.

2. Select SENS MON (sensitive monitor) for off-the-air monitoring.

3. Enter the frequency from the keyboard.



4. Key the transmitter under test and read PL frequency in the upper portion of the right LCD.

NOTE: The PL frequency counter measures frequency inputs in the range of 60 Hz to 270 Hz. The output of the counter is displayed on the right LCD with resolution of .1 Hz. In cases of low PL tone deviation, the value of the tenths digit may fluctuate periodically. It may be necessary to average the displayed values over time to determine the PL frequency within .5 percent accuracy.

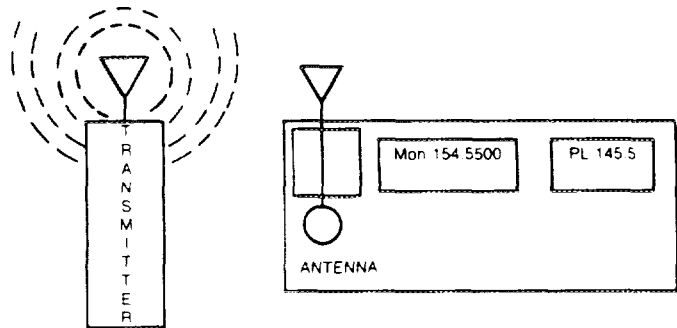

FIGURE 4-6—TEST SET-UP FOR PL COUNTER MEASUREMENT

4.4.5 SIMULTANEOUS OSCILLOSCOPE/DVM OPERATION

The use of separate CRT and LCD displays makes it possible to view signal waveforms on the oscilloscope and simultaneously view the measured digital and analog values of the waveform on the left LCD. To measure an AC waveform (RMS value) and display the waveform on the oscilloscope CRT:

1. Connect the multipurpose input test probe to the circuit to be measured.
2. Move the left Δ cursor to DVM and select AC volts for display.
3. Select the EXT AC position on the oscilloscope "SOURCE" switch.
4. Select the proper Volt per division scale and center the trace.

5. Read RMS volts on the left LCD display in both digital and analog form. Digital displays are for accuracy and analog displays are for use during peaking and dipping adjustments.
6. Simultaneously view the signal waveform on the oscilloscope CRT.

NOTE: This feature can be used while the service monitor is either generating or monitoring a RF frequency or for general purpose troubleshooting of an audio circuit. The AC voltmeter bandwidth is specified to 10 KHz.

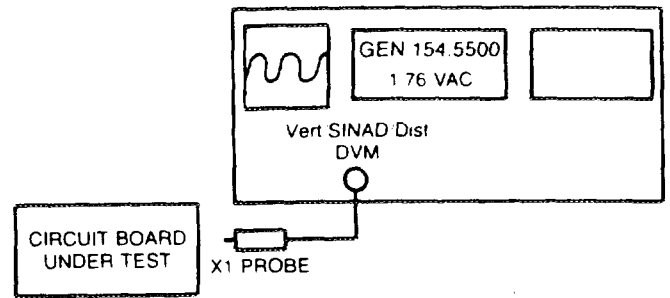

FIGURE 4-7—TEST SET-UP FOR SIMULTANEOUS OSCILLOSCOPE/DVM MEASUREMENT



SECTION 5 APPLICATIONS

5.1.0 SERVICE SHOP SETUPS

This section of the manual guides troubleshooting, diagnosing, and adjusting communications equipment ranging from pocket pagers to repeaters. It contains information on how to connect equipment under test to the R-2200/R-2400 service monitor and how to set the controls and indicators to obtain the anticipated LCD display. Maintain a permanent written log of all measurements and information important to your operation.

CAUTION: These are typical applications and are not all inclusive. Not every test works with every transceiver. Motorola takes no responsibility for their accuracy, applicability or safety. Always refer to your own transceiver's service manual for recommended test methods and specifications.

The service monitor's DVM input is unbalanced (ground referenced). Use an appropriate interface to measure balanced circuits, such as certain receiver audio outputs or telephone lines.

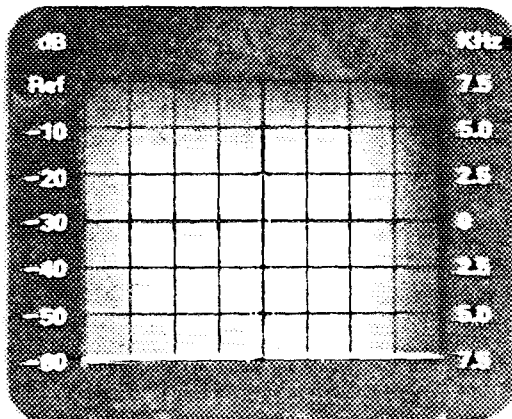

FIGURE 5.1—SPECTRUM ANALYZER DISPLAY

5.1.1 SPECTRUM ANALYZER

The spectrum analyzer, figure 5.1, displays the RF spectrum while center frequency is shown on the LCD display. Use the keyboard to enter the channel center frequency directly. Use the spectrum analyzer to identify interference, trace RF and IF signals, observe transmitter harmonics, check spurious responses and receiver local oscillator radiation. The LCD displays the appropriate frequency and changes the system operating frequency as required. The CRT displays a window of the RF spectrum at either the "Antenna" or "RF In/Out" port in a range selected from 1 MHz to 999.9999 MHz programmable in 100 Hz increments. The observed window for the analyzer can be controlled with the dispersion control. The spectrum analyzer has a dynamic range of at least 55 dB with the step attenuator in the 0 dB position. With the attenuator, the useable range can be extended up to the maximum allowable input level. When using the attenuator, add 10 dB per step attenuation to the actual dB reading on the scope.

5.1.2 OPERATING NOTES FOR THE R-2400 SERVICE MONITOR WITH SPECTRUM ANALYZER

In the normal use of a spectrum analyzer, the user should keep in mind certain characteristics common to this instrument.

1. Noise Floor (grass) - caused by the basic sensitivity of the spectrum analyzer receiver. When the dispersion switch is set to it's widest sweep (1 MHz/div.), the receiver's IF is necessarily set to it's widest bandwidth (approximately 40 kHz) allowing more noise through the IF to be displayed. At the narrower dispersions, 0.1 MHz/div. and .01 MHz/div., the IF bandwidth is reduced to 15 kHz and 6 kHz respectively, causing the noise floor displayed to vary.
2. In the medium and narrow dispersions, the shape of an unmodulated carrier displayed is due partially to the characteristics of the IF filters. The filters used in the R-2400 give the best compromise between shape, attenuation, sweep speed, and RF sweep direction (Image switch).
3. The noise that appears near a strong signal is called Sideband Noise (SBN). It is a measure of the impurity of the signals presented to the spectrum analyzer receiver, either the signal applied from an external RF source (i.e. transmitter) or the service monitor's own 1st mixer's injection, and these noise components will add in the mixer and could both be observed on the CRT. It is important to note that when attempting to judge the quality of an RF carrier that the RF synthesizer in the service monitor could contribute to the SBN of the observed signal.
4. As in any spectrum analyzer, excessively strong signals, even those at a frequency not displayed, could overload the 1st mixer circuit in the service monitor and produce excessive SBN or discrete spurious signals that are not actually present in the applied signal. Therefore, it is always good practice to change the step attenuator in 10 dB steps while observing a suspected spurious signal on the CRT display; if the signal rises (or falls) more than (or less than) 10 dB for a 10 dB step of the attenuator, the mixer is probably being overloaded. The solution is to add enough attenuation to insure a dB for dB change on the display. If an off-screen signal is still too strong to allow observation of the signal of interest, a "suck-out" circuit (either a cavity or discrete component filter) must be inserted to reduce this signal.
5. When a "spurious" signal appears above or below the center frequency displayed, it could be an "image" signal caused by the service monitor's mixer/local oscillator. To determine if this spurious signal is being generated internally, change the "Image" switch and observe if the spur moves to the other side of the display or goes away altogether: if it does, then it is being generated internally and may be ignored.

6. When using the service monitor's "RF In/Out" port in the "Pwr Mon/Anlzd On" mode, there is no directly connected signal path to the spectrum analyzer receiver. Instead, the signal path is loosely coupled through internal capacitance. Thus, a signal of a given power level at a low frequency will appear to be of greater power at a higher frequency. Hence, a transmitter's harmonic power will appear greater than it really is, relative to the level of the carrier display. LEVEL ACCURACY OVER WIDE FREQUENCY RANGES IN THE "Pwr Mon/Anlzd On" MODE IS NOT SPECIFIED. Refer to page 5-6 for a recommended procedure.
7. When using the spectrum analyzer feature, the HORIZ and VERT vernier controls **MUST BE IN THE "Cal" POSITIONS**. Failure to do this may result in an uncalibrated display.

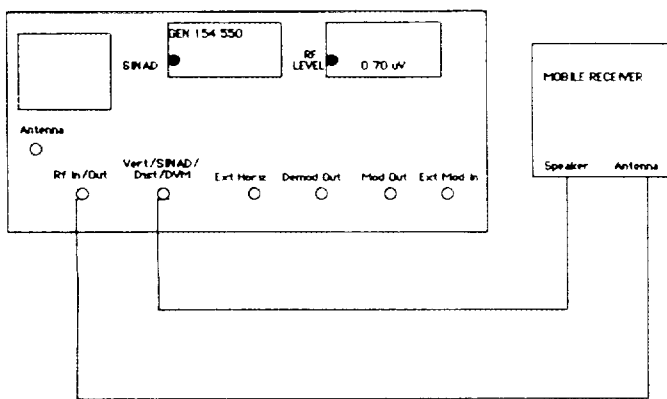

FIGURE 5.2—SINAD/20 dB QUIETING TEST SETUP AND DISPLAY

5.2.0 RECEIVER SENSITIVITY TEST-12 dB SINAD/AUDIO DISTORTION

Use the R-2200/R-2400 signal generator and SINAD meter to measure a receiver's performance by the following procedure:

1. As shown on figure 5.2, connect the Monitor's "RF In/Out" to the antenna connector of the receiver under test. Connect the service monitor's "Vert/Sinad/Dist" to the receiver's audio output. Disable all PL's and open the Squelch.
 2. Set the function switch to "Gen".
 3. Select the RF frequency and enter directly from the keyboard.
 4. Select the "Dev" function on the left LCD. Use "Dev, % + / -" to verify + and - deviations.
 5. Adjust "1 KHz Lvl" control for 60% of rated deviation as indicated on the LCD. To prevent spurious noise modulation, set "Code Synth Lvl" to min and "Ext Lvl" to "Off".
- a. With a 1000uV RF input level, adjust the volume control to rated audio power output. EIA RS-204-C specifies that the receiver be set to produce rated audio power before measuring 12 dB SINAD. A dummy load may be used in place of the speaker.
 - b. Select "Dist" on the left LCD to display distortion or "SINAD" to display SINAD.
6. Set RF Step attenuator to -50 dB and the "RF Vernier" to mid-range. The displayed RF level should indicate about 2uV. Adjust the attenuator (10 dB steps) and the "RF Vernier" until a 12 dB SINAD reading appears on the display.
 7. From the RF level on the display, read the receiver's 12 dB SINAD sensitivity in uV or dBm.

5.3.0 RECEIVER SENSITIVITY TEST 20 DB QUIETING

1. Connect the service monitor to the receiver under test, as shown in Figure 5.2. Set the left LCD to "DVM", "Function" switch to "Gen" and select "FM" or "CW" mode. Press "Gen On/Off" to disable the generate function, indicated by the flashing "Gen" indicator on the left display.
2. Turn on the receiver (un-squelched) and turn up the receiver audio gain to feed audio noise to the monitor (at least 1/4 rated audio power). Read the audio noise voltage fed to the monitor. Note the noise reading (REF) in volts.
3. Press "Gen On/Off" to enable the generator. With all modulation off, adjust the RF level until the display reads 20 dB less than REF above (0.10X the REF voltage).
4. Read the RF level required to produce 20 dB quieting in uV or dBm using the "RF V/dBm" key.

5.4.0 SQUELCH SENSITIVITY TEST

1. Connect the service monitor to the receiver under test, as shown in figure 5.2. Set the "Function" switch to "Gen" and modulation to "FM". Enter the frequency of the receiver under test.
2. To check PL/DPL squelch sensitivity, enter the proper PL/DPL frequency/code from the keyboard. Set modulation switch to "Cont", select PL or DPL mode, enter Tone Data, and key in frequency. Ensure that "Ext Lvl" and "1 KHz Lvl" are off.
3. Adjust the "Code Synth Lvl" control to provide a nominal 750 Hz (500 Hz - 1 KHz) deviation of the PL/DPL code. To check carrier squelch, turn off all modulation.
4. Place "Gen On/Off" switch to off to remove the RF output from the receiver. Set the receiver's squelch control to the point where the receiver just begins to quiet.

5. Return "Gen On/Off" switch to on. Increase the RF Level by adjusting the step attenuator and "RF Vernier" controls until the receiver just unsquelches.
 - a. On the LCD, read minimum squelch sensitivity as uV or dBm. This is the threshold squelch sensitivity of the receiver.
 - b. Determine the tight squelch sensitivity of the receiver by repeating steps 4 and 5 with the receiver's squelch control set to maximum tightness.
6. Enable the receiver's PL/DPL squelch circuit. Fully open the carrier squelch control. Increase the RF level from minimum, as in step 5, until the receiver's squelch just opens. On the right LCD, read the coded squelch sensitivity in uV or dBm.

5.5.0 AUDIO POWER OUTPUT TEST

1. Referring to figure 5.2, set "Function" switch to "Gen" and modulation to "FM". Enter the RF frequency and PL code.
2. Adjust the step attenuator and "RF" Vernier' controls to 1000uV (-47 dBm). Adjust the "1 KHz Lvl" control to 60% of the rated deviation on the KHz scale. Use the "RF In/Out" connector for this test.
3. Select "DVM" "AC" function.
4. Connect a suitable resistive load that can dissipate the receiver's rated audio output, in place of the speaker. (If the receiver is using a "floating" or "bridge" output amplifier, connect a 1:1 isolation transformer across the load resistor).
5. Connect a scope probe to the service monitor's "Vert/SINAD/Dist" input connector and clip the probe across the load resistor or to the isolation transformer.
6. Connect "RF In/Out" to the receiver's antenna port. Adjust the receiver's volume control for the highest voltage reading on the DVM AC scale which does not have clipping or other distortion in excess of the radio's spec as viewed on the oscilloscope.
7. Calculate the audio power by the following formula:

$$\text{Power Out (Watts)} = \frac{(\text{AC volts})^2}{\text{Load Resistance (ohms)}}$$

8. If the receiver does not produce rated audio power output, use the service monitor's oscilloscope and a scope probe to trace through the audio stages and locate the problem.

5.6.0 AUDIO FREQUENCY RESPONSE

1. Use the keyboard to enter the frequency and PL/DPL code (if any) of the receiver under test.
2. Set the "Function" switch to "Gen" and modulation to "FM", step attenuator and vernier controls to 1000uV (-47 dBm).
3. Select and set Tone A to 1000 Hz. Set modulation switch to "Cont".

4. Adjust the "Code Synth Lvl" control for 20% of rated deviation on the Dev scale, for example: 1 KHz in a 5 KHz system. Select "DVM" on the left LCD and "AC" volts.
5. Connect the service monitor's "RF In/Out" port to the receiver's antenna port. Connect the "Vert/SINAD/Dist" input connector to the receiver's speaker output using a scope probe. If the speaker is "floating", use an isolation transformer to avoid shorting the output stage to ground.
6. Adjust the receiver's volume control to obtain a reference level reading on the AC volts scale which is free of clipping at any frequency within the 300 to 3000 Hz band. Return to 1 kHz and note this reading as the reference level (in AC volts).
7. Refer to the audio response curve in the receiver's service manual. Change the Tone A frequency on the tone display LCD to the value for each point on the curve to be measured.
8. Maintain FM deviation at 20% of the rated deviation, as set in step 4. Note the audio level at each frequency. The level in dB must be calculated as $20 \times \log(V/VREF)$ where VREF is the voltage recorded in step 6.
9. EIA RS-204C specifies the frequency response for NBFM receivers over the range of 300Hz to 3000 Hz as follows:
 - a. Audio response for receivers using loudspeakers shall not vary more than +2 dB or -8 dB from a standard 6 dB per octave curve, with reference taken as 1000 Hz.
 - b. Audio response for receivers using headphones or telephone lines shall not vary more than +1 dB or -3 dB from a standard 6 dB per octave curve, with reference taken at 1000 Hz.
10. Plot the resulting values using 0 dB as the reference and compare them with the 6 dB per octave curve in your receiver's service manual or with the EIA specification as shown on figure 5.3.

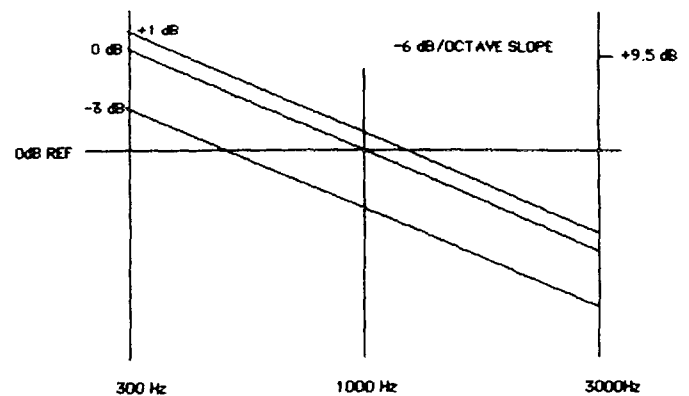

FIGURE 5.3— RECEIVER AUDIO FREQUENCY RESPONSE

5.7.0 MODULATION ACCEPTANCE BANDWIDTH

1. Perform the 12 dB SINAD Sensitivity test with the service monitor in the same set-up as shown in figure 5.2.
2. Increase the RF output level 6 dB above the 12 dB SINAD level, to double the voltage. For example, 0.35uV increased 6 dB = 0.7uV.
3. Turn the "1 KHz LM" control clockwise to increase the deviation until the SINAD level returns to 12 dB. Read the amount of deviation on the display as the modulation acceptance bandwidth of the receiver.
4. A typical modulation acceptance value for a receiver is 7 KHz. Refer to the specification for the specific receiver under test. Any loss of modulation acceptance bandwidth indicates improper alignment or a component failure in a receiver's IF circuit.

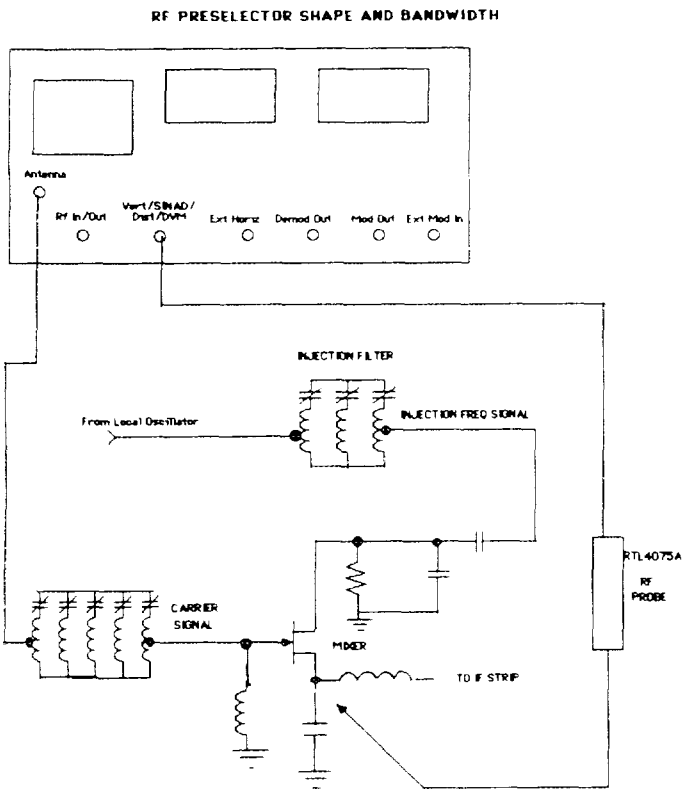

FIGURE 5.4—PROBE SETUP

5.8.0 RF PRESELECTOR SHAPE AND BANDWIDTH

Use this test to insure proper preselector alignment for multi-frequency receivers. Tune the preselector for greater rejection of an interfering frequency from near-by transmitters.

1. Connect the service monitor's "Antenna" to the antenna connector of the receiver under test. Connect the "Vert. SINAD/Dist" port to the RF probe. Connect the probe to the first available low impedance point following the preselector, as shown in figure 5.4.
2. Disable the receiver's mixer injection.
3. Set scope to Ext Vert DC, "Function" to "Hi Gen", modulation to "CW", and the scope sweep control to "100uS/div".
4. Enter the approximate center frequency of the pre-selector. Adjust the RF Level (and scope vertical controls) to produce a trace on the CRT screen at the lowest readable RF level to minimize the possibility of overloading the circuits being tested.
5. Using the Frequency Stepping function, determine at what frequency the peak DC voltage occurs on the DVM or CRT.
6. The 3 dB (.707 of peak) and 6 dB (.5 of peak) bandwidth points can be checked by stepping either up or down in frequency and observing the change in DC level from the RF probe.

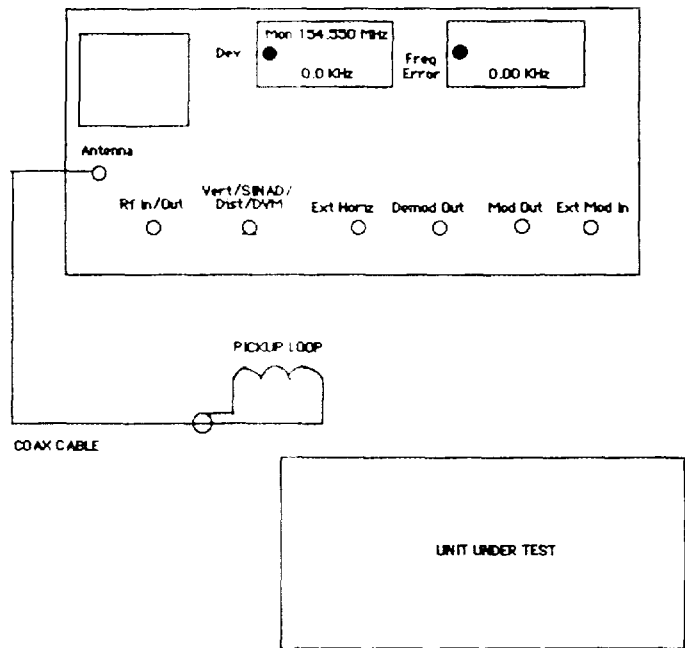

FIGURE 5.5—FREQUENCY ADJUSTMENT SETUP

5.9.0 RECEIVER FREQUENCY ADJUSTMENT

1. Connect the service monitor to the receiver under test, as shown in figure 5.5.
2. Set "Function" switch to "Sens Mon" (or "Anlz Sens Mon" on the R-2400). Program the monitor for the local oscillator frequency.

3. Place the pick-up loop in close proximity to the receiver so that the local oscillator signal is coupled to the monitor input. Using the frequency error function, adjust the local oscillator for the desired frequency.
4. Change the "Function" switch to "Hi Gen" and enter the proper carrier frequency. Introduce sufficient signal level into the RF input to fully quiet the receiver and adjust the discriminator to zero volts DC for receivers requiring such an adjustment. For receivers with quadrature or more critical detectors, adjust detector tuning control or local oscillator injection frequency for minimum distortion or best SINAD performance.
5. For pagers with the battery saver feature, check the local oscillator for pulse operation without removing the unit from its housing.

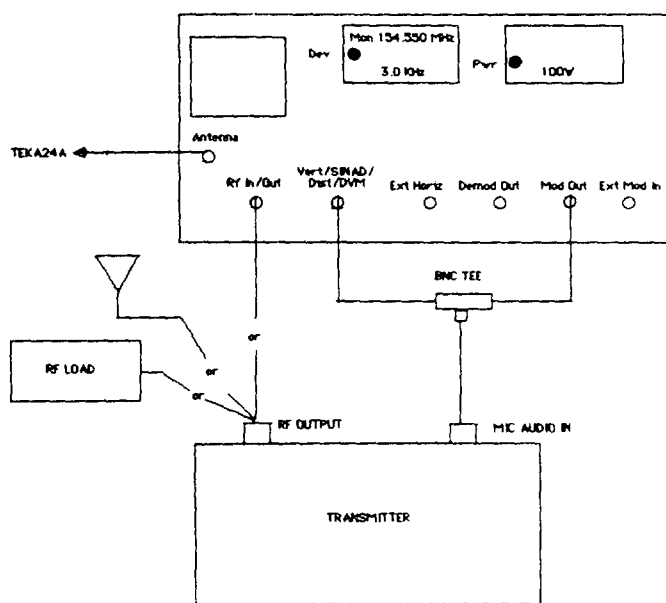

FIGURE 5.6—TRANSMITTER TESTS SETUP

5.10.0 BASIC FM TRANSMITTER TEST: POWER, FREQUENCY, AND DEVIATION

A. Basic Terminated Measurements

1. Connect the service monitor's "RF In/Out" port to the RF output of the unit under test and make the other connections as shown in figure 5.6.

CAUTION: For power output measurements, connect a transmitter only to the service monitor's "RF In/Out" port. **Do not connect it to the service monitor's "Antenna" port.**

The built-in RF load dissipates up to 50 W for three minutes and up to 125 W for one minute. If a technician keys a high-power transmitter into the monitor for a time long enough to threaten overheating the power-measuring circuitry, the system's audible alarm sounds, warning to un-key.

2. Set "Function" switch to "Pwr Mon" (Or "Pwr Mon/Anlcr On"), "FM", and "Squelch" control to threshold. Enter the correct transmitter carrier frequency.
3. Set the step attenuator to -30 dB. For low-power transmitters, it may be necessary to reduce the attenuator setting to un-squelch the monitor. Too high an attenuator setting or too tight a squelch setting inhibits the frequency error display. Accurate measurements require sufficient signal level from the radio to fully quiet the service monitor's receiver.
4. Use good quality cables of minimum length because cable-loss can be a significant factor in RF power measurement, especially at UHF and above. Key the transmitter and read the power indicated on the display.
5. Read the transmitter's frequency error indicated on the display.
6. Refer to the radio's service manual to determine if power and frequency are within spec limits and determine if any adjustments are required.
7. Proceed to check modulation as follows:
 - a. Turn off all modulation sources at the "Mod Out" of the service monitor in order to check the level of PL or DPL deviation from the transmitter. Switch "Function" to "Pwr Mon" to observe recovered audio.
 - b. Key up transmitter with appropriate PL or DPL enabled and read "Dev" from the left LCD. Refer to radio service manual to determine if adjustment is necessary.
 - c. With PL or DPL modulation properly set, introduce 1 KHz modulation to transmitter audio input by adjusting the "1 KHz Lvl" control. Check service manual to determine the minimum level required for proper MIC sensitivity as well as the maximum level required to insure proper IDC function. Read "Mod Out" levels on the DVM by temporarily switching the left LCD to "DVM", and "Source" to "AC".
 - d. At the maximum audio input level, read "Dev" on the display and verify that it falls within the maximum rated system deviation specified in the radio's service manual. Make adjustments as required.
 - e. Verify proper MIC sensitivity by setting "Mod Out" to the minimum threshold level per the service manual and reading corresponding "Dev" on the display.

B. Off-The-Air Measurements

1. Connect the TEKA-24A pick up antenna to the service monitor's "Antenna" connector. Change the "Function" switch to "Sens Mon" (or "Sens Mon/Anlcr On")
2. Operate the transmitter under test either into its own antenna or into a dummy RF load, as shown in figure 5.6.
3. Set the service monitor's "Squelch" control to threshold, and enter the correct carrier frequency.

4. Adjust the attenuator as in step A-3 above, to produce an adequate signal level to the service monitor's receiver.
5. Adjust the transmitter and follow the same procedure outlined in steps A-5 through A-7 above, to measure frequency and deviation.
6. This same method may be used to verify frequency and deviation of a remotely located transmitter by reducing the attenuator setting to fully realize the 1.5uV (10 dB SINAD) sensitivity of the service monitor's "of-the-air" monitor function. To insure sufficient measurement accuracy however, make sure the Monitor receiver is fully quieted as in step A-3 above.

C. Harmonic Power Measurement (R-2400)

1. Referring to Figure 5.6, insert a fixed power attenuator between the RF output connector of the transmitter and the "Antenna" port of the R-2400. The power rating of this attenuator must be at least equal to the rating of the transmitter, and a minimum of 30 dB attenuation. The **input power** to the antenna port **must not exceed 0.5 watt**.
2. Set the "Function" switch to "Sens Mon/Anlzr On" and enter the carrier frequency, as before.
3. Observing the CAUTION above, with a fixed attenuator in series, key the transmitter and set the step attenuator for a peak indication on the spectrum analyzer between the REF and -10 dB graticules. Note the displayed level and the step position in dB. De-key the transmitter.
4. Enter the frequency of the harmonic or spurious signal of interest. Key the transmitter and observe the level of the signal on the spectrum analyzer, adjust the step attenuator if necessary, should the signal be too low to observe. Confirm that the signal changes 10 dB for a 10 dB change in the step attenuator setting (See notes on page 5.2). Note the level of the signal and the step attenuator setting, in dB. De-key the transmitter.
5. Compute the level difference between the carrier and the spur/harmonic as follows:
 - A. Let "REF" = 0 dB, and step position is a negative number.
 - B. PC = displayed level of carrier-(step) i.e.:
-3 dB - (-50 dB) = +47 dB
 - C. P1 = displayed level of spur-(step) i.e.:
-22 dB - (-30 dB) = +8 dB
 - D. The relative difference between the carrier and spur/harmonic levels is P diff = PC - P1 = 47 - 8 = 39 dB.

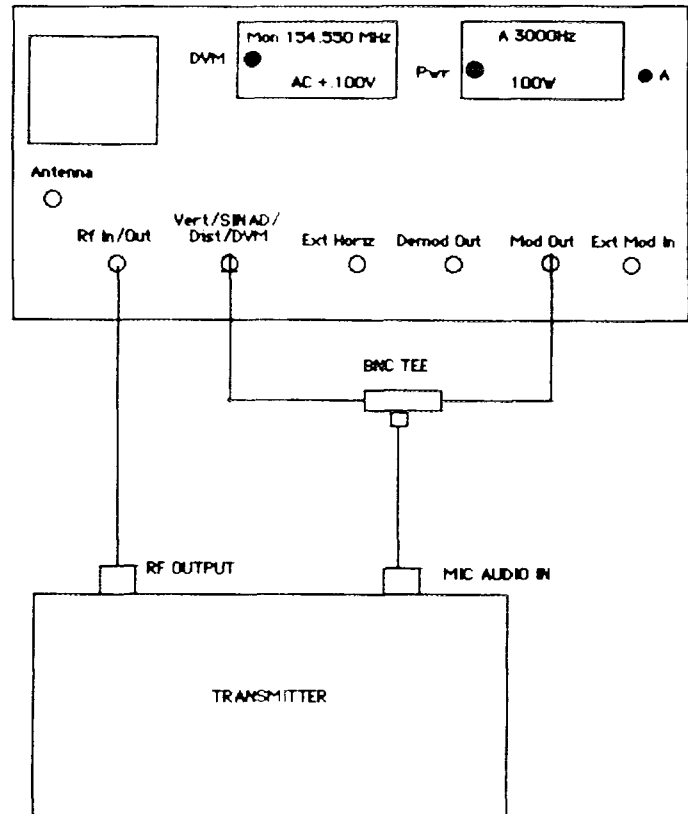

FIGURE 5.7 – TRANSMITTER AUDIO FREQUENCY RESPONSE

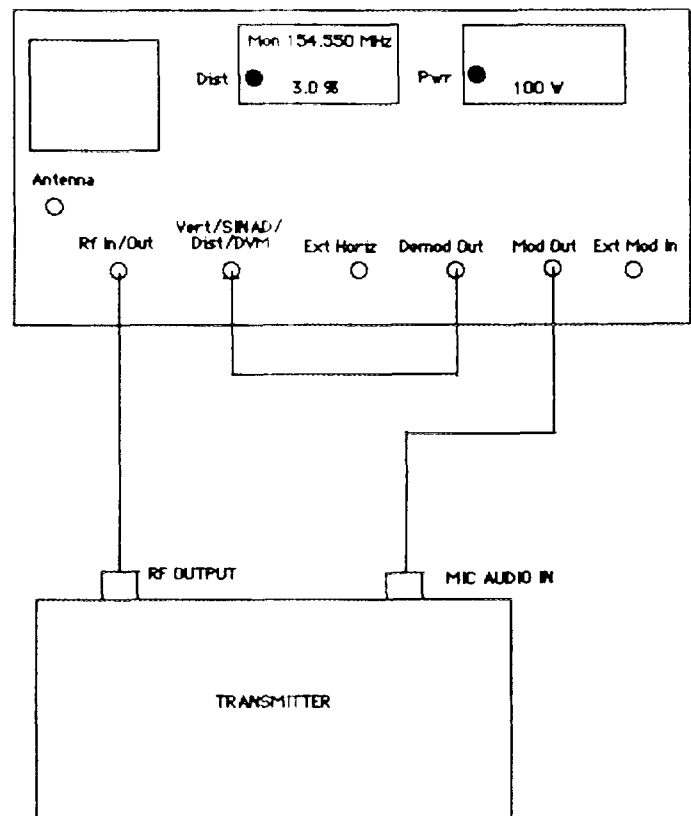

FIGURE 5.8 – TRANSMITTER AUDIO DISTORTION SETUP

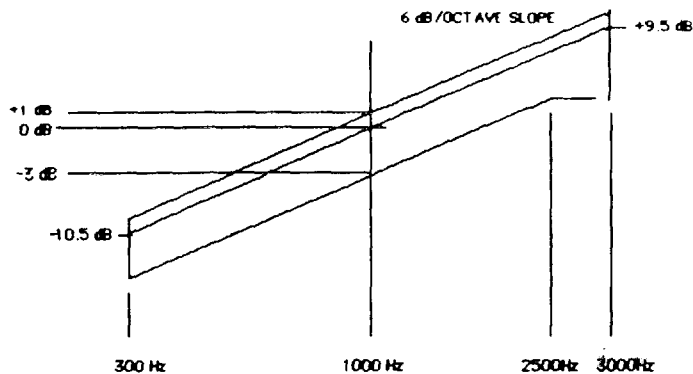

FIGURE 5.9 – AUDIO FREQUENCY RESPONSE

5.11.0 TRANSMITTER AUDIO DISTORTION

1. Before starting this test, adjust the transmitter's IDC to specification.
2. Connect the service monitor to the transmitter, as shown in figure 5.8. Observe caution on page 5-5.
3. Turn off the modulation. Disable PL or DPL. Set "Function" to "Pwr Mon" (or "Pwr Mon/Anlzn On").
4. Key the transmitter and adjust the "1 KHz Lvl" control for 60% of full-rated transmitter deviation on the left LCD.
5. Select "Dist" on the left LCD. Read transmitter % distortion from the display. Unkey the transmitter.

5.12.0 TRANSMITTER AUDIO FREQUENCY RESPONSE

1. As shown in Figure 5.7, connect the service monitor's "RF In/Out" port to the transmitter's RF output and the "Vert/Sinad/Dist" input jack to the "Mod Out" jack through a BNC tee connected to the transmitter's microphone audio input. Disable PL and DPL.
2. Select "DVM" in the left LCD and set the source switch to "AC". Set "Function" to "Pwr Mon", "FM", attenuator to -40 dB modulation to "Cont" and "Tone A". Enter the transmitter frequency. Turn off the "1 KHz Lvl" and "Ext Lvl". When using an R-2400, the "Function" switch may be set to "Pwr Mon/Anlzn On" to observe the occupied bandwidth of the modulated carrier. Set "Disp" to .01 MHz/Div.
3. Enter the required Tone A frequency.
4. Set "Function" to "Pwr Mon" (or "Pwr Mon/Anlzn On"). Key the transmitter and adjust "Code Synth Lvl" to provide 30% of rated transmitter deviation.
5. Note both the transmitter MIC audio input level and the test frequency, for later use.
6. Repeat the above procedure, adjusting "Code Synth Lvl" to maintain 30% of rated deviation, for each modulation frequency to be tested.

7. Plot the data points obtained above in dB relative to the 1 KHz level and compare with the transmitter's specifications. EIA RS-152B specifies that a transmitter's frequency response be within +1 dB or -3 dB of a +6 dB per octave pre-emphasis from 300 to 3000 Hz (6 dB per octave roll-off allowed between 2500 and 3000 Hz). Refer to figure 5.9.

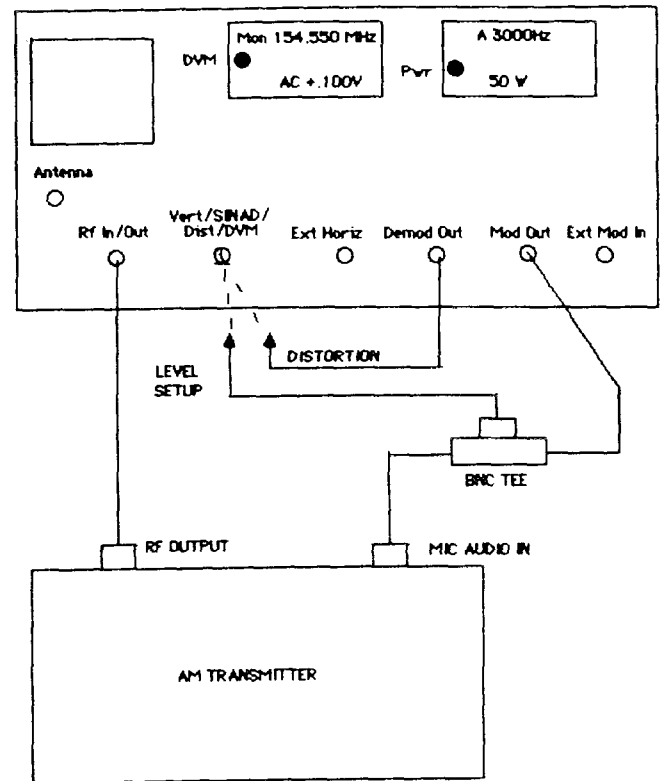

FIGURE 5.10 – AM MODULATION TEST SETUP

5.13.0 AM MODULATION TEST

1. Connect the service monitor's "RF In/Out" to the output connector of the transmitter under test, as shown in figure 5.10. Set "Function" to "Pwr Mon", "AM". Observe caution in basic transmitter tests section.
2. Connect the service monitor's "Mod Out" connector to "Vert/Sinad/Dist" and to the transmitter's microphone input using a BNC tee connector.
3. Set left LCD to "DVM" and the "AC" voltmeter function.
4. Adjust the "1 KHz Lvl" control to provide the proper input signal level to the transmitter. Refer to the transmitter's service manual to obtain the value for this level.
5. Key the transmitter. Read % AM on the left LCD display.

Normally, repairing or replacing cables solves the problem without retuning. Check the duplexer manufacturer's data sheets to determine proper installation.

1. Connect the service monitor to the repeater/duplexer under test, as shown in figure 5.14. Connect the "RF In/Out" to the duplexer's antenna port through an RF tap-off isolating device.

CAUTION: To prevent RF overload into the generator, provide sufficient isolation between the tap-off and the straight-through feed. For example, a 1000W transmitter requires 50 dB isolation.

2. Connect the "Vert/SINAD/Dist" input to the receiver speaker connection. Disconnect the cable from the "RF In/Out" to prevent the transmitter from keying up on repeat.
3. Set left LCD to "Dev", "Function" to "Gen", and enter the receiver frequency.
4. Set the attenuator to -60 dB and the "RF Vernier" control to mid-range.
5. Adjust the "1 KHz Lvl" control to 3.0 kHz DEV on the LCD.

6. Reconnect the cable from "RF In/Out" to the RF tap-off and enable the transmitter to key-up. For example, it may be necessary to provide 0.75 KHz PL/DPL deviation for a PL/DPL accessed repeater.
7. With this generated signal introduced to the RF tap-off, adjust the signal generator Step attenuator and the "RF Vernier" to the 12 dB SINAD level as indicated on the LCD. Note the generator RF Level on the right.
8. Disable the transmitter from key-up. Readjust the signal generator to obtain 12 dB SINAD again. Note the generator RF level.
9. The difference between the RF level for 12 dB SINAD with the transmitter off (step 8) and with the transmitter on (step 7), is the amount of system desensitization.
10. More than 2 dB desensitization may indicate:
 - defective antenna system
 - loose shields
 - transmitter spurs
 - improper or defective duplexer cable

Check them all, before attempting to retune the duplexer.

SECTION 6 MAINTENANCE

6.1.0 BATTERY KIT INSTALLATION

The following instructions detail the correct procedure for battery kit installation, RTP-4021A. See Figure 5-1.

1. Remove and discard 4 nuts holding the battery retaining bars to the battery case. Remove the retaining bars and batteries from the case.
2. Extract the Red and Black battery leads from the battery compartment.
3. Place the battery case in the battery compartment. Screw in the center screws and attach the retaining bars with the 4 screws removed in step 1. The battery case should now be attached with 6 screws.
4. Connect the Red lead to the + terminal, the Black lead to the - terminal on one end and jumper from + to - on the other end of the batteries which places the batteries in series.

6.1.1 BATTERY CHARGING

The following instructions detail the correct procedure for battery charging.

NOTE: Prolonged discharge of the battery can cause permanent damage to the battery. New batteries must be shipped discharged by law.

1. Connect the unit to an AC power source and select "BATTERY" on the rear panel. Turn the unit "ON". The unit will charge in either the "BATTERY" or "EXT DC" positions.
2. Read the battery voltage by selecting "BATT" on the right LCD. A fully charged battery will read 13.6 volts. Overnight charging of the battery can be accomplished by leaving the unit in "ON" or "STANDBY" and will fully charge the newly installed battery.

NOTE: If AC power is connected to the unit, the AC power will be used rather than DC power.

6.1.2 OPERATION FROM AN EXTERNAL DC SOURCE

The following instructions detail the correct procedure to operate the unit from an external DC power source. The connector kit RPX-4097A consists of a connector shell, clamp, and four connector pins. These parts can be used to fabricate a mating plug for the male DC power connector at the back of the service monitor and enables the user to make a DC power cable to interconnect a separate power source to the service monitor.

1. Assemble the connector kit RPX-4097A as follows:
 - pin 1 to + (11 to 17 VDC)
 - pin 2 to NC
 - pin 3 to NC
 - pin 4 to ground

NOTE: Use wire large enough to carry 6 amps with no significant loss, i.e.

- 18 AWG for up to 6 feet
- 20 AWG for up to 16 feet

The terminals supplied are #18-#14 with ins diameter .110", .150"

2. Select "EXT DC" on the rear panel.
3. With no AC applied to the unit, turn the unit on and measure the External DC voltage using the "BATT" measurement on the right LCD. This voltage must be between 11 and 17 volts DC for proper operation.

NOTE: If AC power is connected to the unit, the AC power will be used rather than DC power.

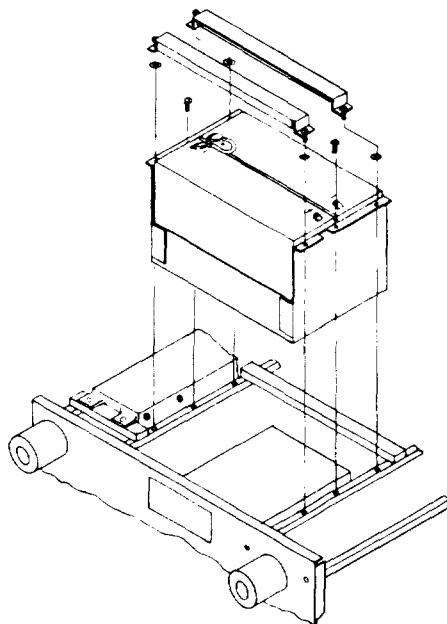

FIGURE 6.1 – BATTERY INSTALLATION

**Communications
Service Monitor
OPERATORS' MANUAL**

**R-2200/2400
68P81069 A79-1B**

